

**VIR Ball valve brass chrome
plated 1" female thread x male
thread 40bar WRAS/VA type
K343 (0401425)**



TECHNICAL SPECIFICATIONS

Type	K343
Material	brass
Surface treatment	chrome plated
Approval	WRAS/VA
Operation	lever
Colour lever	red
Handle material	dacromet steel
Housing construction	2-part
Ball material	hard chrome plated brass
Material housing	brass
Material seal	PTFE
Connection	female thread x male thread
Flow	full
Temperature range	0°C - 150°C
Pressure	40 bar
Size	1"

DIMENSIONS

Ct-1 65 mm

F-1 15 mm

F-2 16 mm

Handle height 65

Lb 76 mm

R 126.5 mm

ØDf 25 mm

ØDi-1 1 "

ØDo-2 1 "

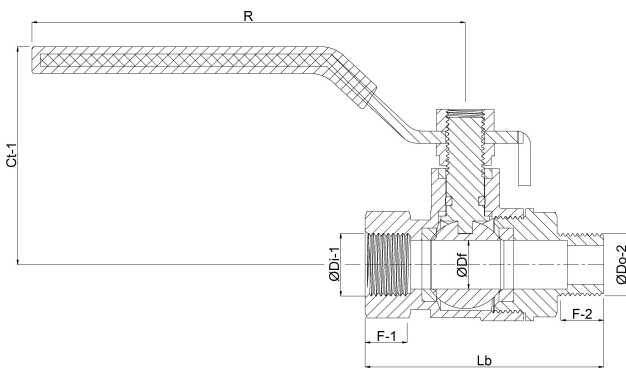

Last modified date: 23/05/2026

Bosta UK Ltd.
Reflection House
Olding Road

Bury St. Edmunds
Suffolk
IP33 3TA
T +44 (0) 1284 716580
E enquiries@bosta.co.uk
<http://www.bosta.com>