

Profec Ball valve PP 40 mm compression 10bar DN32 black type Safe 500 (0707353)



TECHNICAL SPECIFICATIONS

Colour black

Type Safe 500

Material PP

Operation lever

Colour lever red

Handle material PVC-U

Housing construction 3-part

Material housing PP

Material seal hytrel/EPDM

Connection compression

Max. temperature 60 °C

Minimum medium temperature 0 °C
(continuous)

Pressure 10 bar

Size 40 mm

DN 32

DIMENSIONS

Ct-1 92 mm

Lb 238 mm

R 64 mm

ØDf 32 mm

ØDi-1 40 mm

ØDi-2 40 mm

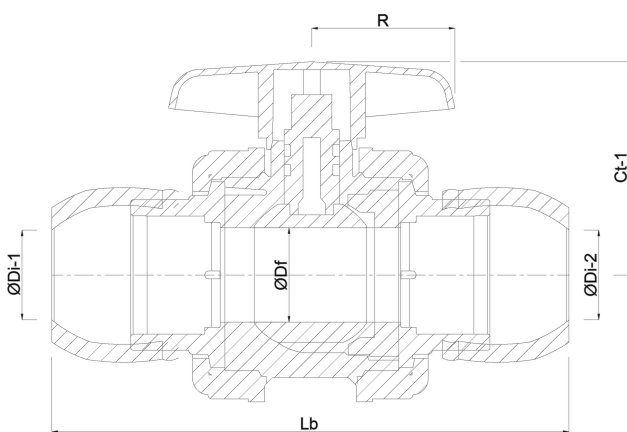

PRODUCT INFORMATION

With secure ball.

Last modified date: 24/05/2026

Bosta UK Ltd.
Reflection House
Olding Road
Bury St. Edmunds
Suffolk
IP33 3TA
T +44 (0) 1284 716580
E enquiries@bosta.co.uk
<http://www.bosta.com>