

**Flotide Sand filter**  
**PE/fibreglass-reinforced**  
**polyester 50 mm / 1 1/2"**  
**metric/imperial glue socket**  
**2,5bar grey type V350**  
**(0891899)**



**FLOTIDE**



**bosta**  
bringing water to life

# TECHNICAL SPECIFICATIONS

Colour	grey
Material	PE/fibreglass-reinforced polyester
Connection	metric/imperial glue socket
Pressure	2,5 bar
Max. temp.	43 °C
Type	V350
Capacity	4 m <sup>3</sup> /h
Size	50 mm / 1 1/2"
Diameter	355 mm
Weight	5 kg
Sand	20 kg
Filter area	0.1 m <sup>2</sup>
Max flow rate	4 m <sup>3</sup> /h
Max. pool vol.	20 m <sup>3</sup>

## DIMENSIONS

A	726 mm
---	--------

B	18 "
B	18 " inch
B	355 mm
C	619 mm
D	550 mm

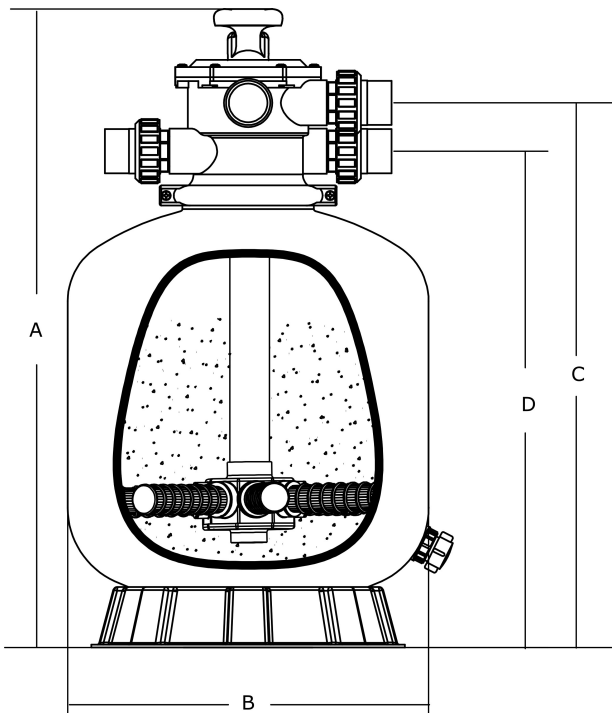

## PRODUCT INFORMATION

PE lined fibreglass reinforced polyester tank with unequalled strength and durability equipped with top-mount 6-way valve.

- Made of fibreglass and polyester (DSM resin). Internal PE lining
- Clamp lock is designed to allow 360 degree rotation to simplify installation
- Top diffuser ensures even distribution of water over the top of the sand bed
- Large sand/water drain for rapid winterising or servicing

- The non-corrosive materials are suitable for all-weather performance
- Easy-to-use multi-port valve lets you select any of the operations with a simple lever action
- UV resistant surface allows the filter to work under direct sunlight
- Warranty period: 2 years

**Last modified date: 24/05/2026**

Bosta UK Ltd.  
Reflection House  
Olding Road  
Bury St. Edmunds  
Suffolk  
IP33 3TA  
T +44 (0) 1284 716580  
E [enquiries@bosta.co.uk](mailto:enquiries@bosta.co.uk)  
<http://www.bosta.com>