

**Profec Flange adaptor PVC-U
DN100 x 110 mm DIN flange x
glue socket 16bar DN100 grey
PN10/16 (0111048)**



TECHNICAL SPECIFICATIONS

Colour	grey
Material	PVC-U
Connection	DIN flange x glue socket
Size	DN100 x 110 mm
Bolt	M16
DN	100
Flange	PN10/16
Outer ø	220 mm
Weight	1.07 kg
Length bolt	100 mm
Thickness	22 mm
Pressure	16 bar
Bolt hole	18 mm
Holes	8

DIMENSIONS

O	18 mm
---	-------

PCD 180 mm

ØDi-1 110 mm

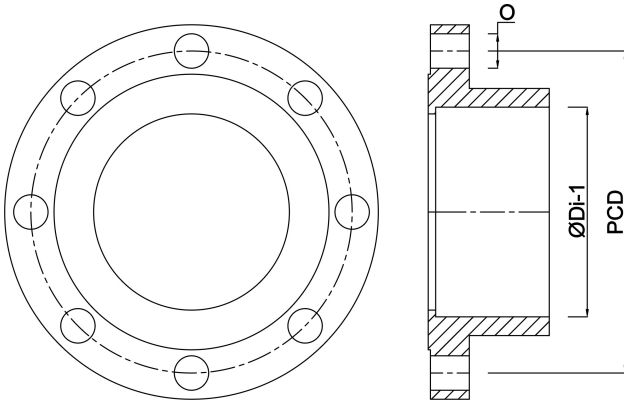

Last modified date: 23/05/2026

Bosta UK Ltd.
Reflection House
Olding Road
Bury St. Edmunds
Suffolk
IP33 3TA
T +44 (0) 1284 716580
E enquiries@bosta.co.uk
<http://www.bosta.com>