

**Profec Flange threaded steel
DN50 x 2" DIN flange x female
thread 16bar black PN10/16
(1180215)**



TECHNICAL SPECIFICATIONS

Colour	black
Material	steel
Connection	DIN flange x female thread
DIN Standard	DIN 2566
Flange	PN10/16
Pressure	16 bar
Size	DN50 x 2"
Diameter	60,3 mm
Outer ø	165 mm
Weight	2.41 kg
Height	28 mm
Thickness	18 mm
PCD	125 mm
Bolt hole	18 mm
Holes	4

DIMENSIONS

O 18 mm

PCD 125 mm

ØDi-1 2 "

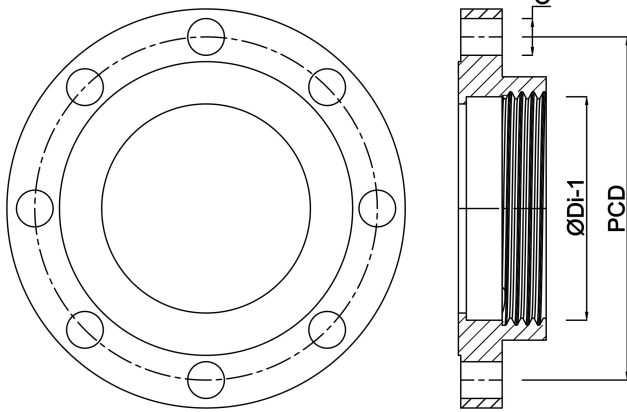

Last modified date: 24/05/2026

Bosta UK Ltd.
Reflection House
Olding Road
Bury St. Edmunds
Suffolk
IP33 3TA
T +44 (0) 1284 716580
E enquiries@bosta.co.uk
<http://www.bosta.com>