

**Profec Ball valve brass nickel
plated 3/4" female thread
25bar type 103 (7000866)**



TECHNICAL SPECIFICATIONS

Type	103
Material	brass
Surface treatment	nickel plated
Operation	butterfly handle
Colour lever	red
Handle material	aluminium
Ball material	hard chrome plated brass
Material housing	brass
Material seal	PTFE
Connection	female thread
Temperature range	-20°C - 120°C
Pressure	25 bar
Size	3/4"

DIMENSIONS

Ct-1	38.8 mm
F-1	12 mm

F-2 12 mm

Lb 54 mm

R 27 mm

ØDf 19 mm

ØDi-1 3/4 "

ØDi-2 3/4 "

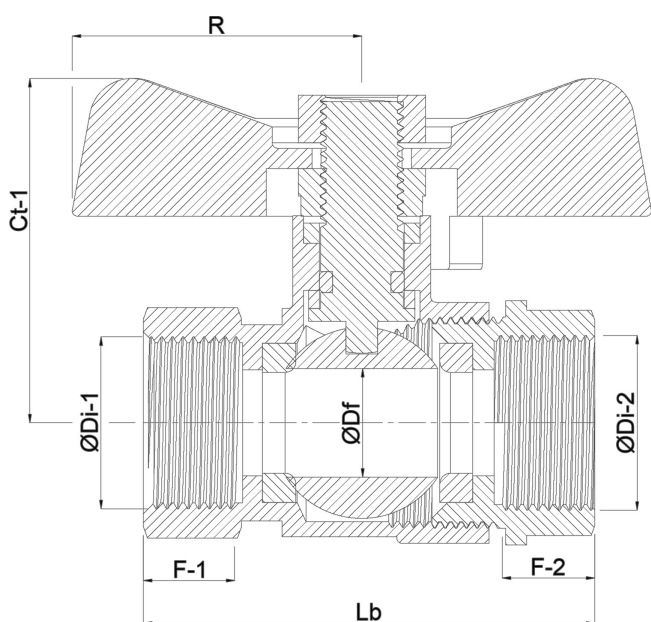

Last modified date: 10/04/2026

Bosta UK Ltd.
Reflection House
Olding Road
Bury St. Edmunds
Suffolk
IP33 3TA
T +44 (0) 1284 716580
E enquiries@bosta.co.uk

<http://www.bosta.com>