

**Profec Flange threaded steel  
zinc plated DN125 x 5" DIN  
flange x female thread DN125  
PN10/16 (1080219)**



# TECHNICAL SPECIFICATIONS

Material	steel
Surface treatment	zinc plated
Connection	DIN flange x female thread
DIN Standard	DIN 2566
Flange	PN10/16
Size	DN125 x 5"
Bolt	M16
DN	125
Diameter	139,7 mm
Outer ø	250 mm
Weight	6.13 kg
Thickness	22 mm
Bolt hole	18 mm
Holes	8

## DIMENSIONS

O	18 mm
---	-------

PCD

210 mm

ØDi-1

5 "

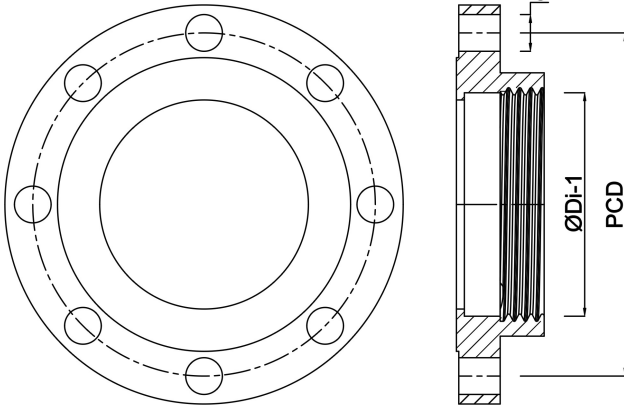

**Last modified date: 24/05/2026**

Bosta UK Ltd.  
Reflection House  
Olding Road  
Bury St. Edmunds  
Suffolk  
IP33 3TA  
T +44 (0) 1284 716580  
E [enquiries@bosta.co.uk](mailto:enquiries@bosta.co.uk)  
<http://www.bosta.com>