

**Profec Blind flange PVC-U
DN25 x 32 mm DIN flange
16bar DN25 grey PN10/16
(0111021)**



TECHNICAL SPECIFICATIONS

Colour	grey
Material	PVC-U
Connection	DIN flange
Size	DN25 x 32 mm
Bolt	M12
Packaging	120 pcs
DN	25
Flange	PN10/16
Outer ø	115 mm
Weight	0.206 kg
Length bolt	60 mm
Thickness	14 mm
Pressure	16 bar
Bolt hole	14 mm
Holes	4

DIMENSIONS

O

14 mm

PCD

86 mm

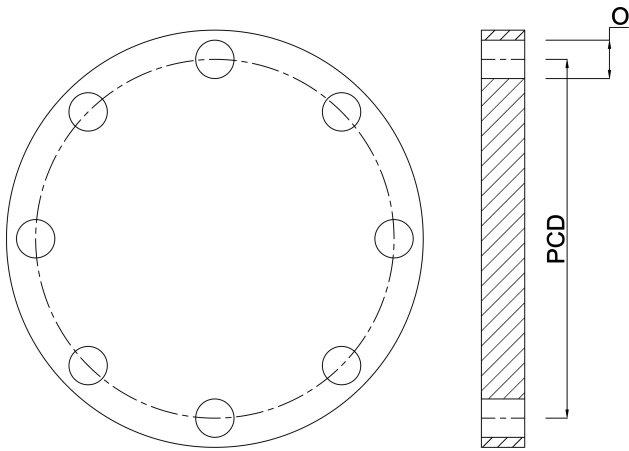

PRODUCT INFORMATION

For PCD, bolt hole size and number see Technical specifications "How to identify a flange" at the back of the catalogue (PCD equals K)

Last modified date: 23/05/2026

Bosta UK Ltd.
Reflection House
Olding Road
Bury St. Edmunds
Suffolk
IP33 3TA
T +44 (0) 1284 716580
E enquiries@bosta.co.uk
<http://www.bosta.com>