

Flange adaptor steel 8" square flange x butt welding black (0200583)



TECHNICAL SPECIFICATIONS

Colour	black
Material	steel
Connection	square flange x butt welding
Thickness	8 mm
Bolt hole	13 mm
Holes	4
Size	8"
Diameter	200 mm
Outer dimension flange	228 x 228

DIMENSIONS

G-1	180 mm
G-2	180 mm
H-1	8 mm
Hole spacing	180 x 180 mm
Lb	228 mm
Lb-2	228 mm

O 13 mm

T 8 mm

ØDi-1 200 mm

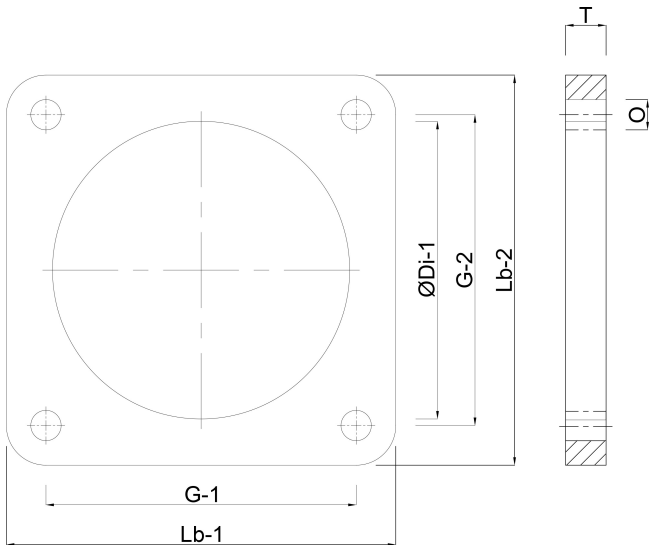

Last modified date: 07/03/2026

Bosta UK Ltd.
Reflection House
Olding Road
Bury St. Edmunds
Suffolk
IP33 3TA
T +44 (0) 1284 716580
E enquiries@bosta.co.uk
<http://www.bosta.com>