

Counter current system PP 75 mm glue socket 400VAC type STP-3000 (0180566)



TECHNICAL SPECIFICATIONS

Material	PP
Shaft	stainless steel
Material impeller 1	PPO
Material seal	SiC-SiC
Connection	glue socket
Type	STP-3000
Output Power	4 HP
Size	75 mm
Voltage	400VAC
Power	3 kW
Max flow rate	65 m ³ /h
IP value	IP55

DIMENSIONS

E	395 mm
h1	635 mm
H	340 mm

A 410 mm

B 156 mm

C 470 mm

D 75 mm

F 77 mm

G 1110 mm

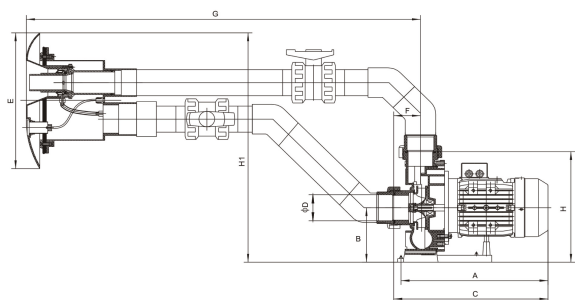
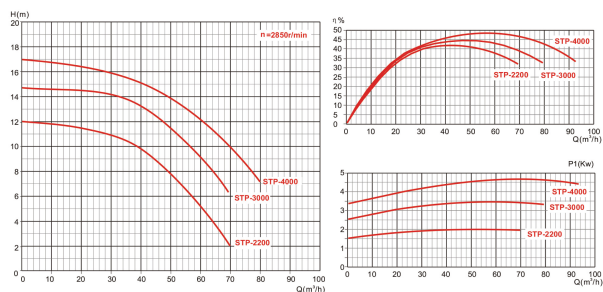

PRODUCT INFORMATION

Adjustable counterflow for swimming training. This jet stream is ready for easy installation. It is possible to regulate the jet strength and air suction on the nozzle which is 40 mm in diameter. The direction of the nozzle is adjustable. The nozzle, suction and pneumatic switch are positioned in the front cover panel of the equipment.

Features:

- Suitable for all type of pools
- Counterflow nozzle 40 mm (regulation water-air)
- Front cover panel with attractive design
- Electropneumatic switch with safety element
- IP 55 protection
- Insulation: Class F
- Motor shaft in stainless steel AISI-304
- Motor housing in aluminium L-2521
- Including 2 x 75mm ball valves

Last modified date: 05/10/2025

Bosta UK Ltd.
Reflection House
Olding Road
Bury St. Edmunds
Suffolk
IP33 3TA
T +44 (0) 1284 716580
E enquiries@bosta.co.uk
<http://www.bosta.com>