

**3-way ball valve T-bore PVC-U  
40 mm glue socket 10bar DN32  
grey type T-bore side  
connection (0111522)**



# TECHNICAL SPECIFICATIONS

Colour grey

Type T-bore

Material PVC-U

Operation lever

Colour lever red

Handle material PVC-U

Material housing PVC-U

Material seal PTFE/EPDM

Ball bore T-bore

Connection type side connection

Connection glue socket

Temperature range 0°C - 60°C

Pressure 10 bar

Shaft PVC

Size 40 mm

DN 32

# DIMENSIONS

Ct-1 82 mm

Lb 169 mm

R 100 mm

ØDf 32 mm

ØDi-1 40 mm

ØDi-2 40 mm

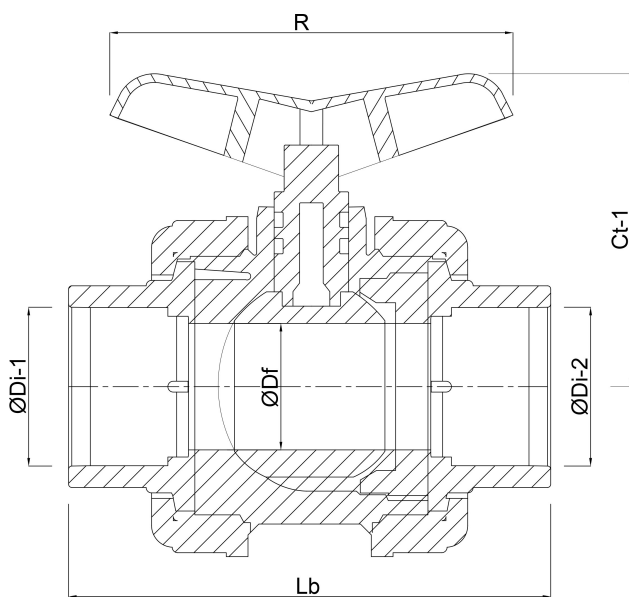

**Last modified date: 23/05/2026**

Bosta UK Ltd.  
Reflection House  
Olding Road  
Bury St. Edmunds

Suffolk  
IP33 3TA  
T +44 (0) 1284 716580  
E [enquiries@bosta.co.uk](mailto:enquiries@bosta.co.uk)  
<http://www.bosta.com>