

**Profec Gate valve cast iron
GGG 50 epoxy coating DN150
DIN flange 16bar blue PN10/16
type 302 (7038247)**



TECHNICAL SPECIFICATIONS

Colour	blue
Type	302
Material	cast iron GGG 50
Surface treatment	epoxy coating
Operation	handwheel
Colour lever	blue
Handle material	cast iron
Material valve	cast iron EPDM coated
Material spindle	stainless steel
Material housing	cast iron GGG 50
Material seal	NBR
Connection	DIN flange
Max. temperature	110 °C
RAL number	RAL5017
Flange according to DIN	DIN 2501/PN10
Pressure	16 bar
Max. temp.	120 °C

Size DN150

Length 210 mm

Flange PN10/16

Outer ø 283 mm

PCD 240 mm

Holes 8

DIMENSIONS

Construction length din 3352/2c/f4

Ct-1 472 mm

L 210 mm

L 210 mm

PCD 240 mm

R 260 mm

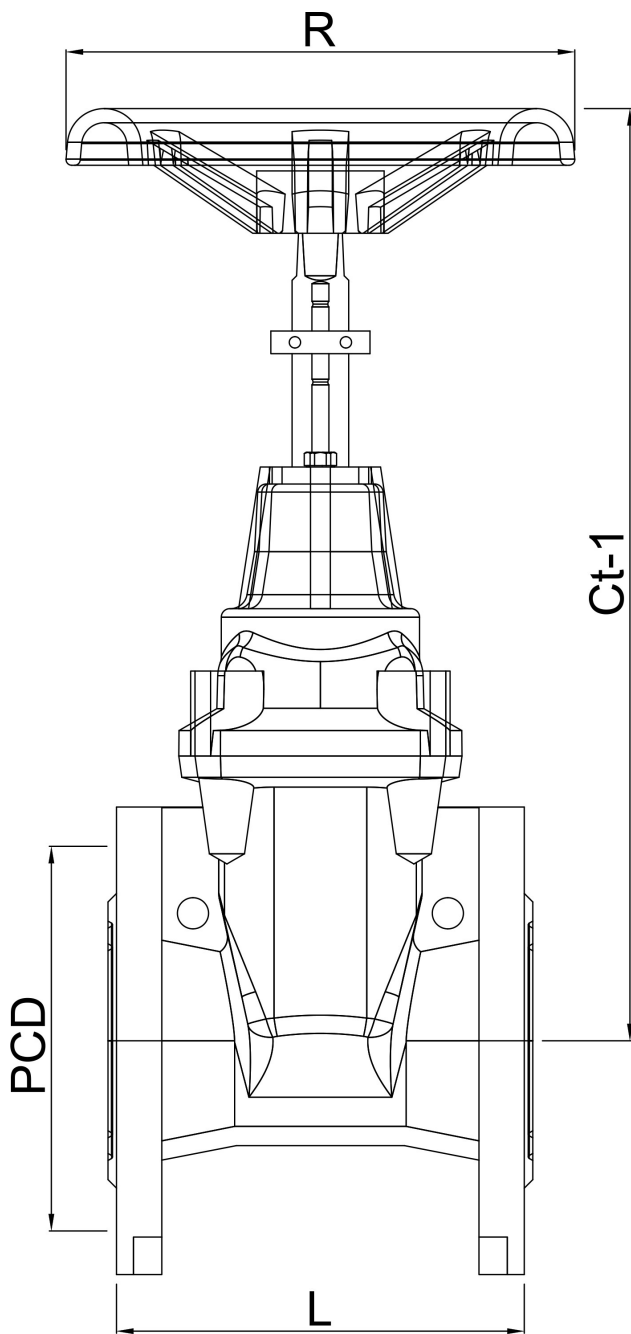

Last modified date: 27/05/2026

Bosta UK Ltd.
Reflection House
Olding Road
Bury St. Edmunds

Suffolk
IP33 3TA
T +44 (0) 1284 716580
E enquiries@bosta.co.uk
<http://www.bosta.com>