

**Profec Nr. 40 Bend 45° cast iron
galvanised 1 1/4" female
thread x male thread 25bar
DVGW (1004006)**



TECHNICAL SPECIFICATIONS

Material	cast iron
Surface treatment	galvanised
Approval	DVGW
Connection	female thread x male thread
Fitting nr.	Nr. 40
Temperature range	-20°C - 120°C
Pressure	25 bar
Size	1 1/4"

DIMENSIONS

Cb-1	64 mm
Cb-2	64 mm
F-1	20 mm
F-2	25 mm
ØDi-1	1 1/4 "
ØDo-2	1 1/4 "
β	45 °

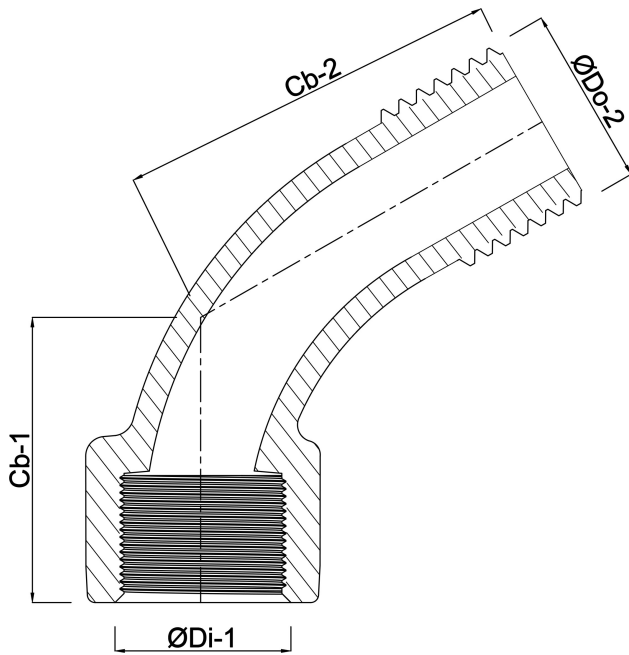

Last modified date: 24/05/2026

Bosta UK Ltd.
Reflection House
Olding Road
Bury St. Edmunds
Suffolk
IP33 3TA
T +44 (0) 1284 716580
E enquiries@bosta.co.uk
<http://www.bosta.com>