

**VIR Ball valve brass chrome
plated 2 1/2" female thread
25bar WRAS/VA type 340B
(0400977)**



TECHNICAL SPECIFICATIONS

Type	340B
Material	brass
Surface treatment	chrome plated
Approval	WRAS/VA
Operation	lever
Colour lever	blue
Handle material	dacromet steel
Housing construction	2-part
Ball material	hard chrome plated brass
Material housing	brass
Material seal	PTFE
Connection	female thread
Flow	full
Temperature range	0°C - 150°C
Size	2 1/2"
Pressure	25 bar

DIMENSIONS

Ct-1 117 mm

F-1 25 mm

F-2 25 mm

Handle height 117

Lb 141 mm

R 201.5 mm

ØDf 65 mm

ØDi-1 2 1/2 "

ØDi-2 2 1/2 "

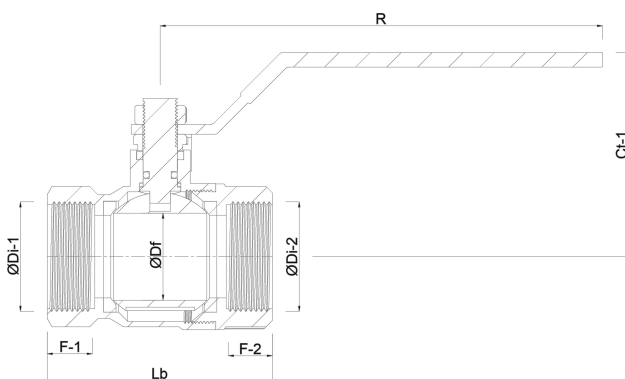

Last modified date: 23/05/2026

Bosta UK Ltd.
Reflection House

Olding Road
Bury St. Edmunds
Suffolk
IP33 3TA
T +44 (0) 1284 716580
E enquiries@bosta.co.uk
<http://www.bosta.com>