

**Flange PP DN80 x 3" DIN flange
x female thread 6bar DN80
black PN10/16 type reinforced
(0707207)**



TECHNICAL SPECIFICATIONS

Colour	black
Type	reinforced
Material	PP
Material seal	rubber reinforced with nylon
Connection	DIN flange x female thread
Flange	PN10/16
Thickness	18 mm
Bolt hole	18 mm
Size	DN80 x 3"
Packaging	65 pcs
DN	80
Outer ø	195 mm
Pressure	6 bar
Holes	8

DIMENSIONS

O	18 mm
---	-------

PCD 160 mm

ØDi-1 3 "

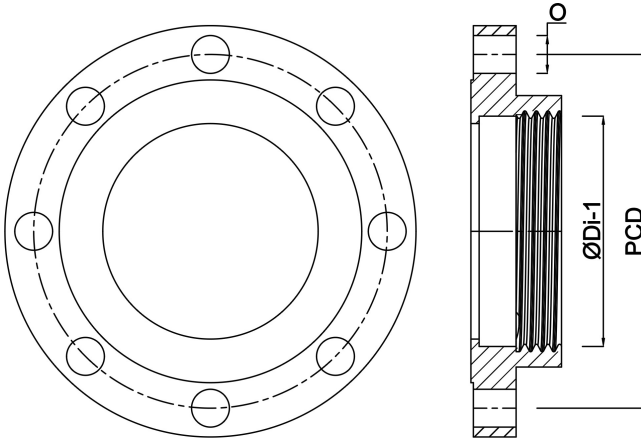

Last modified date: 13/03/2026

Bosta UK Ltd.
Reflection House
Olding Road
Bury St. Edmunds
Suffolk
IP33 3TA
T +44 (0) 1284 716580
E enquiries@bosta.co.uk
<http://www.bosta.com>