

**Grundfos Variable speed  
circulation pump stainless  
steel DN32 flange 10bar 1.22A  
230VAC black/red type  
MAGNA1 32-80FN EuP ready  
(7039262)**



GRUNDFOS 

# TECHNICAL SPECIFICATIONS

Colour black/red

Material stainless steel

Pump body stainless steel

Material impeller 1 fibreglass-reinforced PES

Connection flange

Voltage 230VAC

Max. temperature 110 °C

Minimum medium temperature -15 °C  
(continuous)

Impellers 1

Frequency 50 Hz

Maximum ambient temperature 40 °C

Pressure 10 bar

Minimum ambient temperature 0 °C

Type MAGNA1 32-80FN EuP ready

Max. head 8 m

Size DN32

Ampere

1.22 A

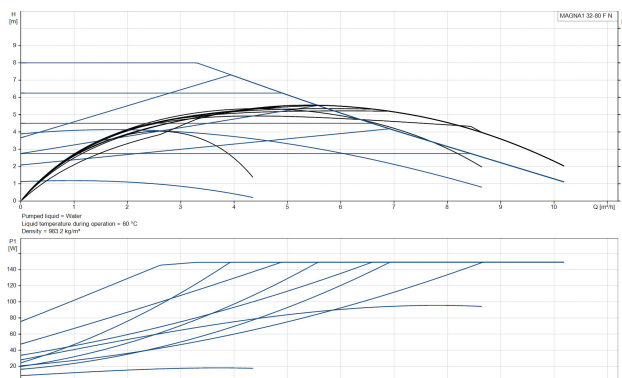
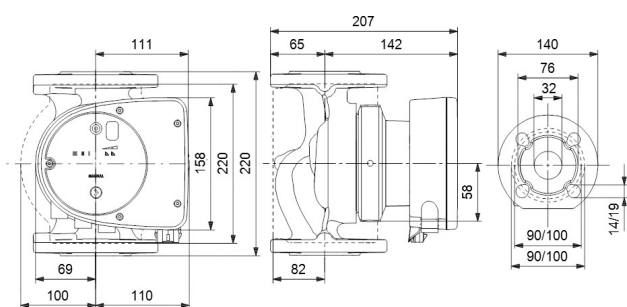

## PRODUCT INFORMATION

The new MAGNA1 is the simple option for a job well done. It is the perfect choice when replacing older circulators and due to its compliance with the EuP 2015 regulations, substantial savings on electricity is a reality. The ideal choice for basic performance needs in applications where basic system control and monitoring is desired. Monitoring via the fault relay, ensuring peace of mind. Digital start/stop input available for remote pump control. Continuous operation and reduced downtime with the wireless twin pump function(available on twin-head pumps) High energy efficiency resulting in substantial savings on electricity. Easy setup and operation via the simple user interface. No maintenance due to the canned-rotor type design. MAGNA1 is the simple and efficient choice for most applications including heating, main pump, mixing loops, heating surfaces, cooling, air conditioning surfaces, ground source heat pump systems and smaller chiller applications.

Features:

- Proportional-pressure control.
- Constant-pressure control.
- Constant-curve/constant-speed duty.
- No external motor protection required.
- Insulating shells supplied with single-head pumps for heating systems.
- Wide temperature range due to thermal separation of the control box and pumped media.

**Last modified date: 27/05/2026**

Bosta UK Ltd.  
Reflection House  
Olding Road  
Bury St. Edmunds  
Suffolk  
IP33 3TA  
T +44 (0) 1284 716580  
E [enquiries@bosta.co.uk](mailto:enquiries@bosta.co.uk)  
<http://www.bosta.com>