

**3-way ball valve L-bore PVC-U  
25 mm glue socket 10bar DN20  
grey type L-bore side  
connection (0111642)**



# TECHNICAL SPECIFICATIONS

Colour grey

Type L-bore

Material PVC-U

Operation lever

Colour lever red

Handle material PVC-U

Material housing PVC-U

Material seal PTFE/EPDM

Ball bore L-bore

Connection type side connection

Connection glue socket

Temperature range 0°C - 60°C

Pressure 10 bar

Size 25 mm

DN 20

## DIMENSIONS

Ct-1 52 mm

Lb 123 mm

R 85 mm

$\varnothing$ Df 20 mm

$\varnothing$ Di-1 25 mm

$\varnothing$ Di-2 25 mm

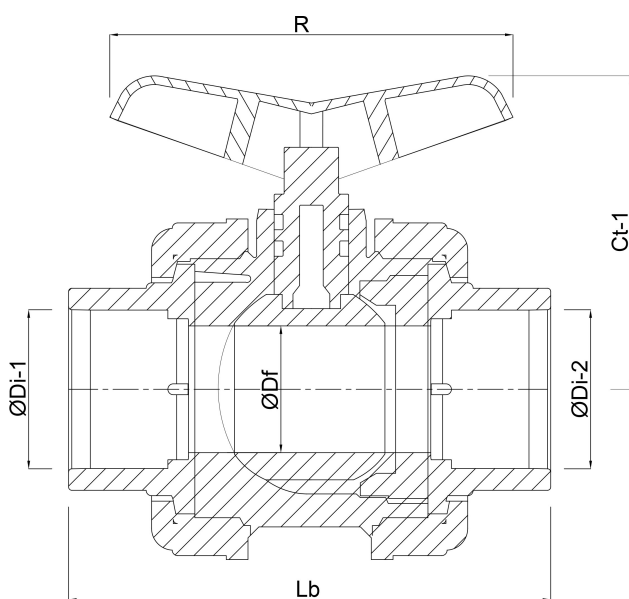

**Last modified date: 23/05/2026**

Bosta UK Ltd.  
Reflection House  
Olding Road  
Bury St. Edmunds  
Suffolk  
IP33 3TA  
T +44 (0) 1284 716580  
E [enquiries@bosta.co.uk](mailto:enquiries@bosta.co.uk)  
<http://www.bosta.com>