

Profec Nr. 3 Bend 90° stainless steel 316 1 1/2" male thread 10bar (0080767)



TECHNICAL SPECIFICATIONS

Material stainless steel 316

Connection male thread

Fitting nr. Nr. 3

Pressure 10 bar

Size 1 1/2"

DIMENSIONS

Cb-1 160 mm

Cb-2 160 mm

ØDo-1 1 1/2 "

ØDo-2 1 1/2 "

β 90 °

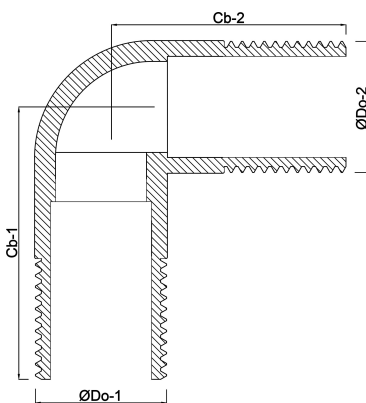

Last modified date: 13/03/2026

Bosta UK Ltd.
Reflection House
Olding Road
Bury St. Edmunds
Suffolk
IP33 3TA
T +44 (0) 1284 716580
E enquiries@bosta.co.uk
<http://www.bosta.com>