

**Profec Ball valve ductile cast
iron GGG40 varnished DN40
DIN flange 16bar blue PN10/16
(0401600)**

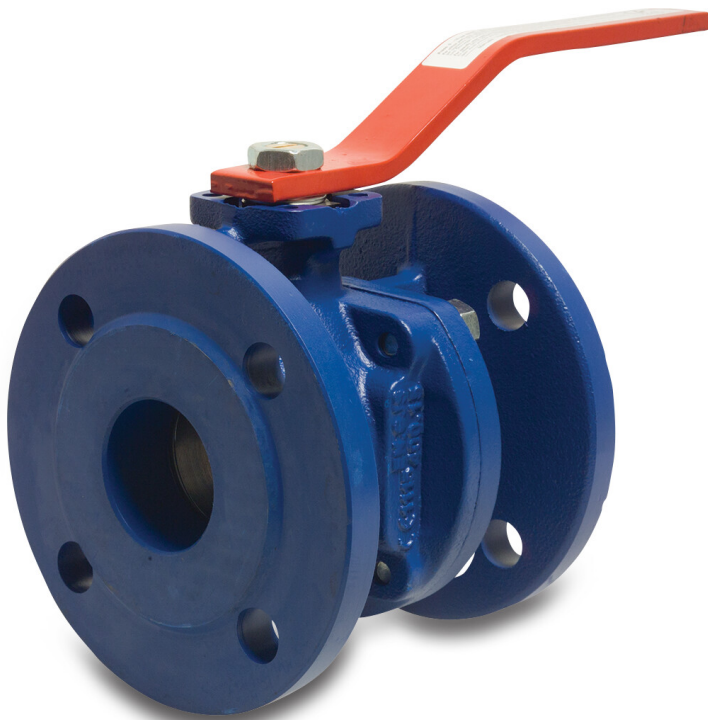

TECHNICAL SPECIFICATIONS

Colour	blue
Material	ductile cast iron GGG40
Surface treatment	varnished
Operation	lever
Colour lever	red
Handle material	steel
Housing construction	2-part
Ball material	brass
Material spindle	brass
Material housing	ductile cast iron GGG40
Material seal	NBR
Connection	DIN flange
Temperature range	-10°C - 100°C
Pressure	16 bar
Size	DN40
Flange	PN10/16
PCD	110 mm

Bolt hole 18 mm

Holes 4

DIMENSIONS

Ct-1 125 mm

Handle height 92

L 140 mm

PCD 110 mm

R 230 mm

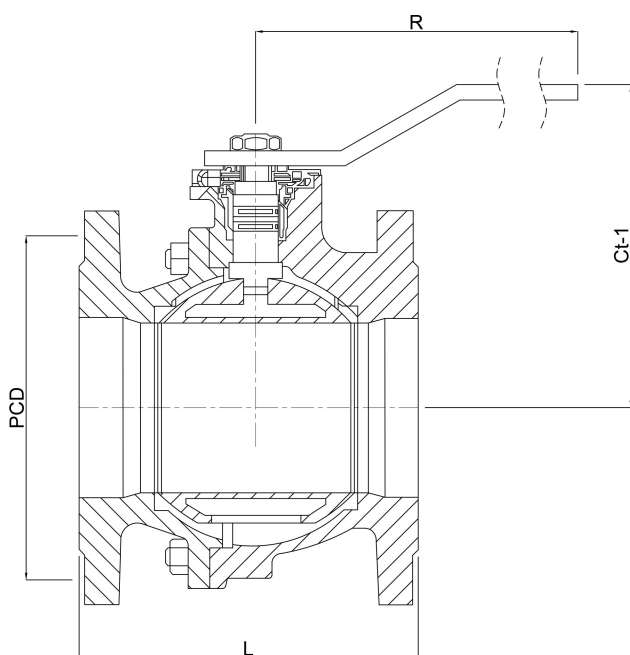

Last modified date: 23/05/2026

Bosta UK Ltd.
Reflection House
Olding Road
Bury St. Edmunds
Suffolk
IP33 3TA
T +44 (0) 1284 716580
E enquiries@bosta.co.uk
<http://www.bosta.com>