

Grundfos Multi-stage centrifugal pump stainless steel DN35 DIN flange 4,45A 400VAC type CRI 1-33 A FGJ I V HQQV (7039671)



GRUNDFOS 

TECHNICAL SPECIFICATIONS

Material stainless steel

Shaft stainless steel 316

Pump body stainless steel 316

Material impeller 1 stainless steel 304

Connection DIN flange

Voltage 400VAC

Temperature range -20°C - 90°C

Maximum ambient temperature 40 °C

Minimum ambient temperature 0 °C

Type CRI 1-33 A FGJ I V HQQV

Output Power 3 HP

Max. head 200 m

Size DN35

Power 2.2 kW

Impellers 33

Ampere 4,45 A

Max flow rate 2.4 m³/h

Efficiency 85,9 %

Press 35

Motor RPM 2770

DIMENSIONS

Cb-1 75 mm

Cb-2 75 mm

H-1 1165 mm

L 250 mm

W-1 210 mm

ØDi-1 35 mm

ØDi-2 35 mm

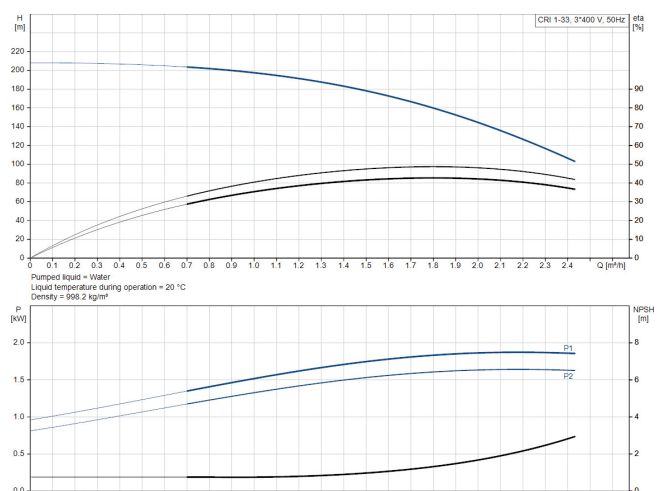
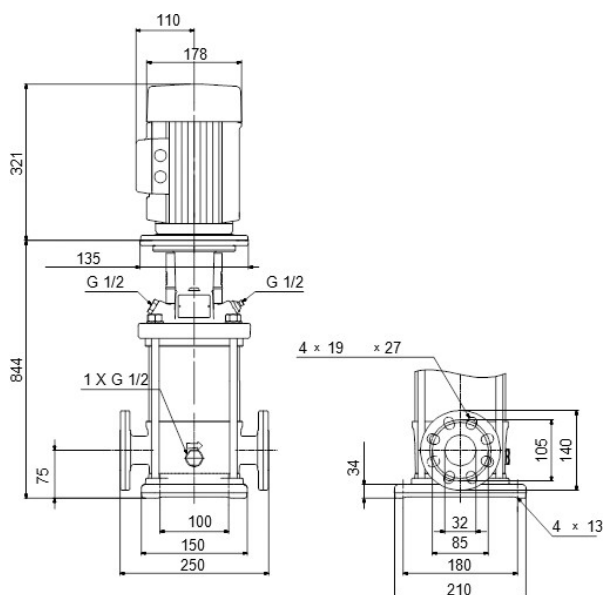

PRODUCT INFORMATION

Grundfos CRI pumps are vertical, non-self-priming, multistage, in-line, centrifugal pumps for installation in pipe systems and mounting on a foundation, suitable for industrial applications. This design provides a more compact pump design and pipework. CR pumps are designed for a variety of applications ranging from the pumping of potable water to the pumping of chemicals. The pumps are therefore suitable for a wide range of pumping systems where the performance and material of the pump meet specific demands.

Last modified date: 10/05/2026

Bosta UK Ltd.
Reflection House
Olding Road
Bury St. Edmunds
Suffolk
IP33 3TA
T +44 (0) 1284 716580
E enquiries@bosta.co.uk
<http://www.bosta.com>