

**VIR Ball valve brass chrome
plated 1 1/4" male thread
40bar WRAS/VA type K348
(0401269)**



TECHNICAL SPECIFICATIONS

Type	K348
Material	brass
Surface treatment	chrome plated
Approval	WRAS/VA
Operation	lever
Colour lever	red
Handle material	dacromet steel
Housing construction	2-part
Ball material	hard chrome plated brass
Material housing	brass
Material seal	PTFE
Connection	male thread
Flow	full
Temperature range	0°C - 150°C
Pressure	40 bar
Size	1 1/4"

DIMENSIONS

Ct-1 71 mm

F-1 18 mm

F-2 18 mm

Handle height 71

Lb 100 mm

R 126.5 mm

ØDf 32 mm

ØDo-1 1 1/4 "

ØDo-2 1 1/4 "

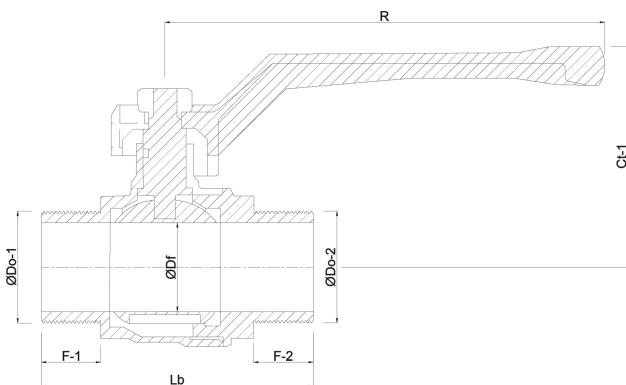

Last modified date: 23/05/2026

Bosta UK Ltd.
Reflection House

Olding Road
Bury St. Edmunds
Suffolk
IP33 3TA
T +44 (0) 1284 716580
E enquiries@bosta.co.uk
<http://www.bosta.com>