

Profec Ball valve brass nickel plated 6" female thread 20bar type 119 (0401072)



TECHNICAL SPECIFICATIONS

Type 119

Material brass

Surface treatment nickel plated

Operation lever

Colour lever red

Handle material dacromet steel

Housing construction

Ball material hard chrome plated brass

Material housing brass

Material seal PTFE

Connection female thread

Pressure 20 bar

Size 6"

DIMENSIONS

Ct-1 180 mm

F-1 29 mm

F-2 29 mm

Handle height 190

Lb 220 mm

R 310 mm

ØDf 125 mm

ØDi-1 6 "

ØDi-2 6 "

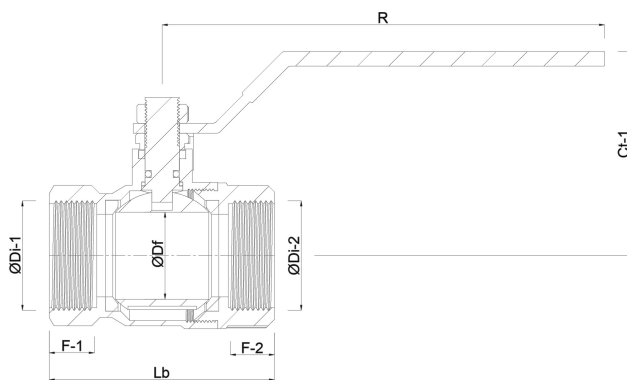

Last modified date: 23/05/2026

Bosta UK Ltd.
Reflection House
Olding Road
Bury St. Edmunds
Suffolk
IP33 3TA
T +44 (0) 1284 716580
E enquiries@bosta.co.uk
<http://www.bosta.com>