

**Profec Flange adaptor PVC-U  
DN80 x 90 mm DIN flange x  
glue socket 16bar DN80 grey  
PN10/16 (0111047)**



# TECHNICAL SPECIFICATIONS

Colour	grey
Material	PVC-U
Connection	DIN flange x glue socket
Size	DN80 x 90 mm
Bolt	M16
DN	80
Flange	PN10/16
Outer ø	200 mm
Weight	0.78 kg
Length bolt	90 mm
Thickness	20 mm
Pressure	16 bar
Bolt hole	18 mm
Holes	8

## DIMENSIONS

O	18 mm
---	-------

PCD

160 mm

ØDi-1

90 mm

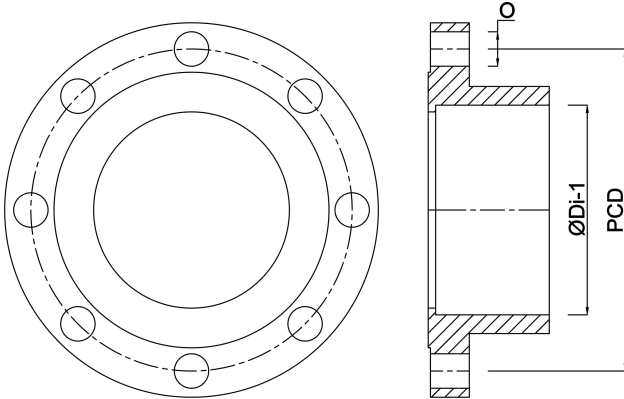

**Last modified date: 23/05/2026**

Bosta UK Ltd.  
Reflection House  
Olding Road  
Bury St. Edmunds  
Suffolk  
IP33 3TA  
T +44 (0) 1284 716580  
E [enquiries@bosta.co.uk](mailto:enquiries@bosta.co.uk)  
<http://www.bosta.com>