

**Profec Blind flange PVC-U
DN200 x 225 mm DIN flange
10bar DN200 grey PN10
(0111032)**



TECHNICAL SPECIFICATIONS

Colour	grey
Material	PVC-U
Connection	DIN flange
Size	DN200 x 225 mm
Bolt	M20
Packaging	4 pcs
DN	200
Flange	PN10
Outer ø	340 mm
Weight	1.97 kg
Length bolt	110 mm
Thickness	30 mm
Pressure	10 bar
Bolt hole	22 mm
Holes	8

DIMENSIONS

O 22 mm

PCD 295 mm

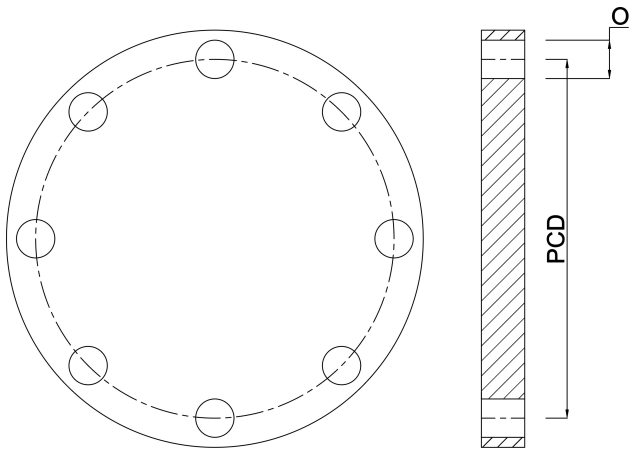

PRODUCT INFORMATION

For PCD, bolt hole size and number see Technical specifications "How to identify a flange" at the back of the catalogue (PCD equals K)

Last modified date: 23/05/2026

Bosta UK Ltd.
Reflection House
Olding Road
Bury St. Edmunds
Suffolk
IP33 3TA
T +44 (0) 1284 716580
E enquiries@bosta.co.uk
<http://www.bosta.com>