

# VIR Ball valve brass chrome plated 3/8" male thread 40bar WRAS/VA type K348 (0401265)



# TECHNICAL SPECIFICATIONS

Type	K348
Material	brass
Surface treatment	chrome plated
Approval	WRAS/VA
Operation	lever
Colour lever	red
Handle material	dacromet steel
Housing construction	2-part
Ball material	hard chrome plated brass
Material housing	brass
Material seal	PTFE
Connection	male thread
Flow	full
Temperature range	0°C - 150°C
Pressure	40 bar
Size	3/8"

# DIMENSIONS

Ct-1 41 mm

F-1 10 mm

F-2 10 mm

Handle height 41

Lb 54 mm

R 81 mm

ØDf 10 mm

ØDo-1 3/8 "

ØDo-2 3/8 "

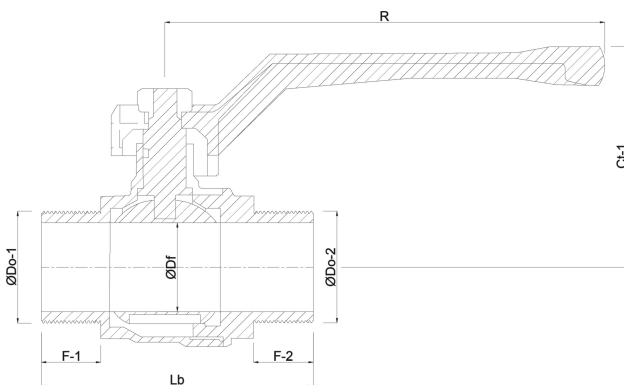

**Last modified date: 23/05/2026**

Bosta UK Ltd.  
Reflection House

Olding Road  
Bury St. Edmunds  
Suffolk  
IP33 3TA  
T +44 (0) 1284 716580  
E [enquiries@bosta.co.uk](mailto:enquiries@bosta.co.uk)  
<http://www.bosta.com>