

**Profec 1-piece Ball valve
stainless steel 316 3/8" female
thread 69bar light (0090893)**



TECHNICAL SPECIFICATIONS

Material stainless steel 316

Operation lever

Colour lever blue

Handle material stainless steel

Housing construction 1-part

Model light

Material housing stainless steel 304

Material seal PTFE

Connection female thread

Gasket PTFE

Flow reduced

Temperature range -10°C - 150°C

Pressure 69 bar

Size 3/8"

Length 44 mm

DIMENSIONS

Ct-1	32 mm
F-1	11.5 mm
F-2	11.5 mm
Lb	43,5 mm
R	90 mm
ØDf	7 mm
ØDi-1	3/8 "
ØDi-2	3/8 "

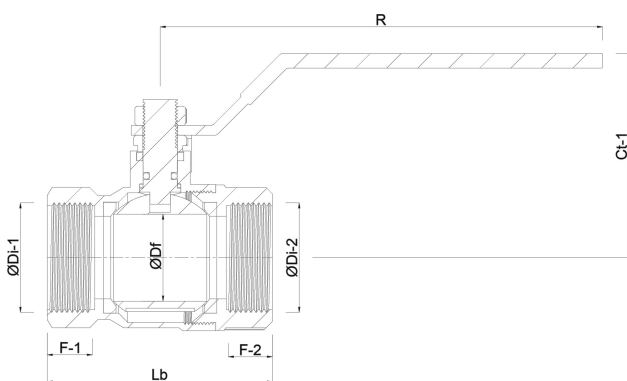

Last modified date: 22/05/2026

Bosta UK Ltd.
 Reflection House
 Olding Road
 Bury St. Edmunds
 Suffolk
 IP33 3TA
 T +44 (0) 1284 716580
 E enquiries@bosta.co.uk
<http://www.bosta.com>