

Profec Flange flat steel DN200 x 220,0 mm DIN flange x butt welding 10bar PN10 (1180244)



TECHNICAL SPECIFICATIONS

Material	steel
Connection	DIN flange x butt welding
DIN Standard	DIN 2576
Flange	PN10
Pressure	10 bar
Size	DN200 x 220,0 mm
Inner ø	221,8 mm
Outer ø	340 mm
Weight	9.25 kg
Thickness	24 mm
PCD	295 mm
Bolt hole	22 mm
Holes	8

DIMENSIONS

O	22 mm
PCD	295 mm

ØDi-1

221.8 mm

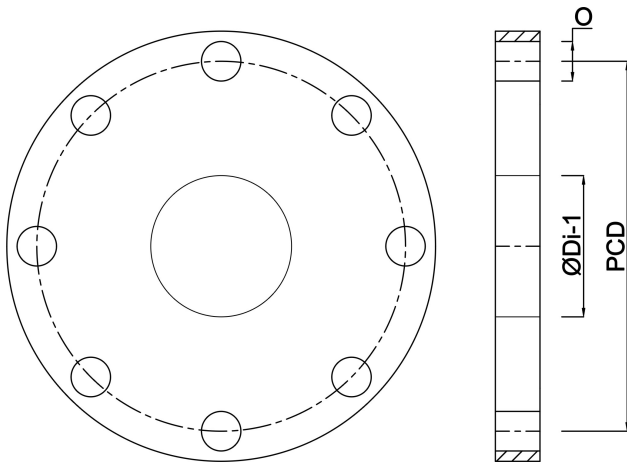

Last modified date: 24/05/2026

Bosta UK Ltd.
Reflection House
Olding Road
Bury St. Edmunds
Suffolk
IP33 3TA
T +44 (0) 1284 716580
E enquiries@bosta.co.uk
<http://www.bosta.com>