

Waterco Commercial pool pump 6" x 4" flange 10,4A 400VAC black type Hydrostar Plus 5.5 kW (7029522)



WATERCO
EUROPE LTD
Water, the liquid of life

TECHNICAL SPECIFICATIONS

Colour	black
Type	Hydrostar Plus
Shaft	stainless steel 431
Pump body	PP GF
Material impeller 1	noryl
Material seal	carbon steel
Connection	flange
Voltage	400VAC
Width	603 mm
Height	521.7 mm
Frequency	50 Hz
IP value	IPX5
Capacity	122,4 m ³ /h
Output Power	7,5 HP
Size	6" x 4"
Type	5.5 kW
Length	1190 mm

Weight 73 kg

Power 5.5 kW

Ampere 10,4 A

Motor RPM 2930

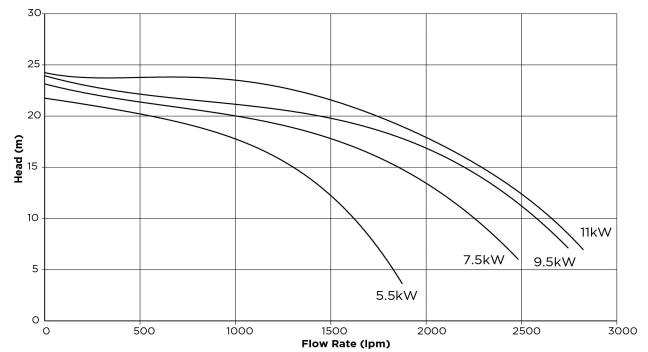
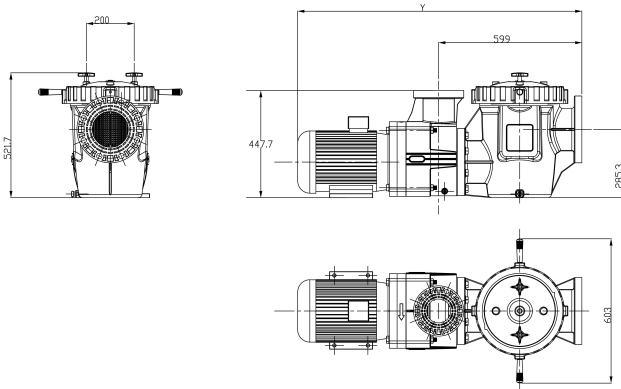

PRODUCT INFORMATION

Waterco Hydrostar Plus pumps are high performance corrosion resistant thermoplastic pumps equipped with 6" flanged inlet port & 4" flanged outlet port, purpose built for aquatic facilities, water parks and large commercial swimming pools. The pump body does not rust or corrode and able to withstand damage from many types of water treatment chemicals. The pump itself weighs less than its steel counterparts without any sacrifice in strength and durability. Their weight makes them easier to ship to the job site and easier to install.

Features:

- Heavy duty IP55 motor with 431 stainless steel shaft
- 4" JIS Flanged Discharge Port
- 6" ANSI Flanged Suction Port
- UV stabilised glass filled polypropylene housing
- 16 L molded polypropylene strainer basket
- Clear polycarbonate strainer lid enables an instant view of the strainer basket
- High grade mechanical seal - carbon/graphite with 316 stainless steel

- Glass filled noryl impeller for long lasting reliability

Last modified date: 26/05/2026

Bosta UK Ltd.
Reflection House
Olding Road
Bury St. Edmunds
Suffolk
IP33 3TA
T +44 (0) 1284 716580
E enquiries@bosta.co.uk
<http://www.bosta.com>