

**Profec Blind flange PVC-U  
DN32 x 40 mm DIN flange  
16bar DN32 grey PN10/16  
(0111022)**



# TECHNICAL SPECIFICATIONS

Colour	grey
Material	PVC-U
Connection	DIN flange
Size	DN32 x 40 mm
Bolt	M16
Packaging	90 pcs
DN	32
Flange	PN10/16
Outer ø	141 mm
Weight	0.295 kg
Length bolt	70 mm
Thickness	15 mm
Pressure	16 bar
Bolt hole	18 mm
Holes	4

## DIMENSIONS

O 18 mm

PCD 100 mm

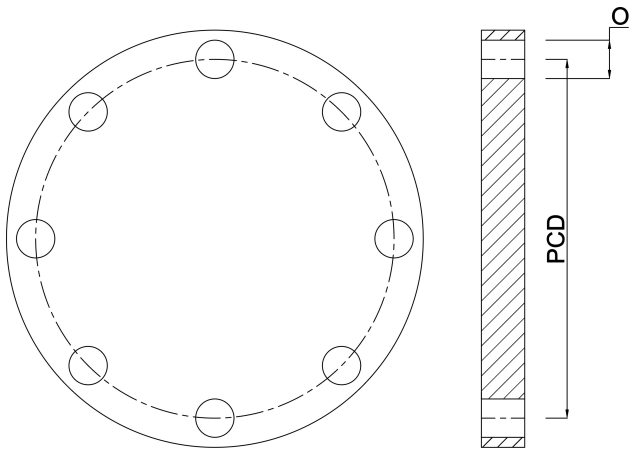

## PRODUCT INFORMATION

For PCD, bolt hole size and number see Technical specifications "How to identify a flange" at the back of the catalogue (PCD equals K)

**Last modified date: 23/05/2026**

Bosta UK Ltd.  
Reflection House  
Olding Road  
Bury St. Edmunds  
Suffolk  
IP33 3TA  
T +44 (0) 1284 716580  
E [enquiries@bosta.co.uk](mailto:enquiries@bosta.co.uk)  
<http://www.bosta.com>