

# Profec Flange flat steel DN25 x 33,7 mm DIN flange x butt welding 10bar PN10 (1180232)



# TECHNICAL SPECIFICATIONS

Material	steel
Connection	DIN flange x butt welding
DIN Standard	DIN 2576
Flange	PN10
Pressure	10 bar
Size	DN25 x 33,7 mm
Inner ø	34,4 mm
Outer ø	115 mm
Weight	1.11 kg
Thickness	16 mm
PCD	85 mm
Bolt hole	14 mm
Holes	4

## DIMENSIONS

O	14 mm
PCD	85 mm

ØDi-1

34.1 mm

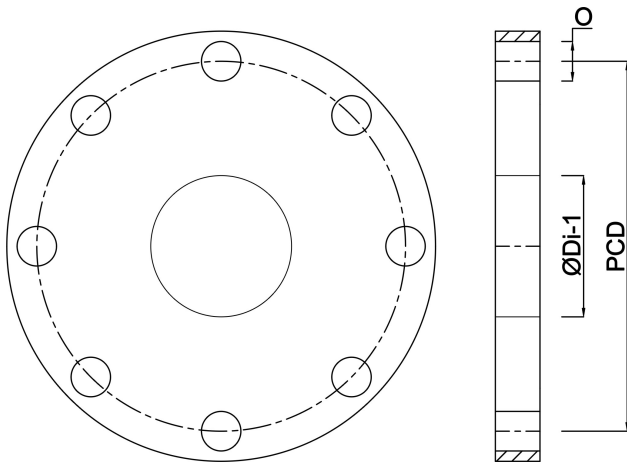

**Last modified date: 24/05/2026**

Bosta UK Ltd.  
Reflection House  
Olding Road  
Bury St. Edmunds  
Suffolk  
IP33 3TA  
T +44 (0) 1284 716580  
E [enquiries@bosta.co.uk](mailto:enquiries@bosta.co.uk)  
<http://www.bosta.com>