

**VIR Ball valve brass chrome
plated 1/2" female thread
40bar WRAS/VA type 340R
(0400952)**



TECHNICAL SPECIFICATIONS

Type	340R
Material	brass
Surface treatment	chrome plated
Approval	WRAS/VA
Operation	lever
Colour lever	red
Handle material	dacromet steel
Housing construction	2-part
Ball material	hard chrome plated brass
Material housing	brass
Material seal	PTFE
Connection	female thread
Flow	full
Temperature range	0°C - 150°C
Size	1/2"
Pressure	40 bar

DIMENSIONS

Handle height 53

ØDf 15 mm

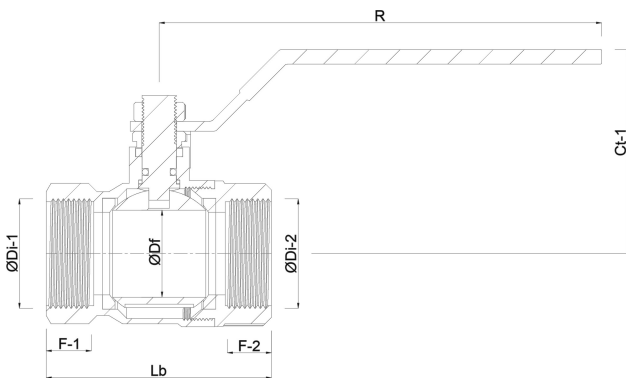

Last modified date: 23/05/2026

Bosta UK Ltd.
Reflection House
Olding Road
Bury St. Edmunds
Suffolk
IP33 3TA
T +44 (0) 1284 716580
E enquiries@bosta.co.uk
<http://www.bosta.com>