

**Profec Butterfly valve PVC-U 90  
mm flange 10bar DN80 grey  
PN6/10 type 7000 (0111415)**



# TECHNICAL SPECIFICATIONS

Colour	grey
Type	7000
Material	PVC-U
Operation	lever
Colour lever	blue
Handle material	aluminium
Material valve	PVC-U
Shaft	stainless steel 316
Material spindle	PVC
Material housing	PVC-U
Material seal	EPDM
Connection	flange
Fire-safe	No
Flange	PN6/10
Temperature range	10°C - 60°C
Size	90 mm
DN	80

Height 53 mm

Pressure 10 bar

Bolt hole 18 mm

Holes 8

## DIMENSIONS

Ct-1 153 mm

PCD 160/169 mm

R 263 mm

W-1 53 mm

W-2 104 mm

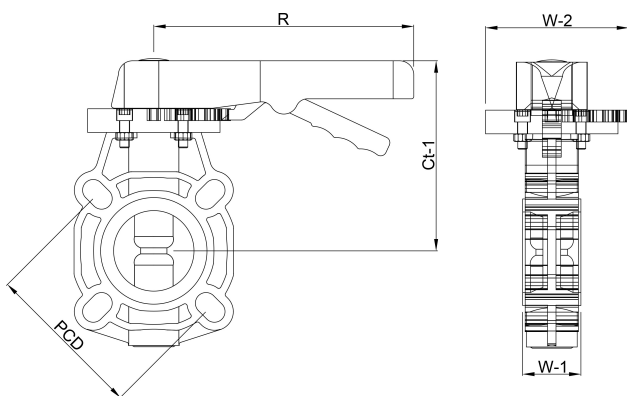

## PRODUCT INFORMATION

According to ISO/DIN.

**Last modified date: 23/05/2026**

Bosta UK Ltd.  
Reflection House  
Olding Road  
Bury St. Edmunds  
Suffolk  
IP33 3TA  
T +44 (0) 1284 716580  
E [enquiries@bosta.co.uk](mailto:enquiries@bosta.co.uk)  
<http://www.bosta.com>