

**DAB Pressure set
technopolymer 1" female
thread 8bar 10A 230VAC green
type ESYBOX (7040087)**



TECHNICAL SPECIFICATIONS

Colour	green
Material	technopolymer
Pump body	technopolymer
Material (spring)	stainless steel 303
Material impeller 1	technopolymer
Connection	female thread
Voltage	230VAC
Max. temperature	40 °C
Minimum medium temperature (continuous)	0 °C
Maximum ambient temperature	50 °C
Pressure	8 bar
Type	ESYBOX
Max. head	65 m
Tank	2 ltr
Size	1"
Power	1.4 kW

Impellers	5
Ampere	10 A
Max flow rate	7.2 m ³ /h
BEP Capacity	60.2
BEP Head	3.94
PORlh	69.8
PORhh	36.3
PORlq	2.758
PORhq	4.728

DIMENSIONS

Cb-1	165.2 mm
Cl-1	65 mm
Cr-1	57 mm
Cr-2	126.2 mm
Cr-3	106 mm
Ct-1	70 mm
H	352 mm
L	564 mm

W-1

263 mm

ØDi-1

1 "

ØDi-2

1 "

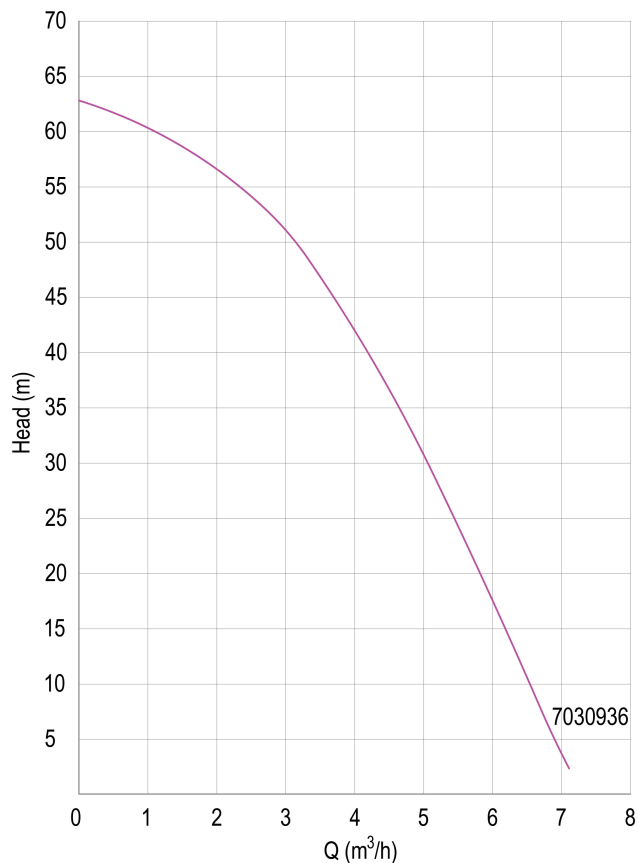
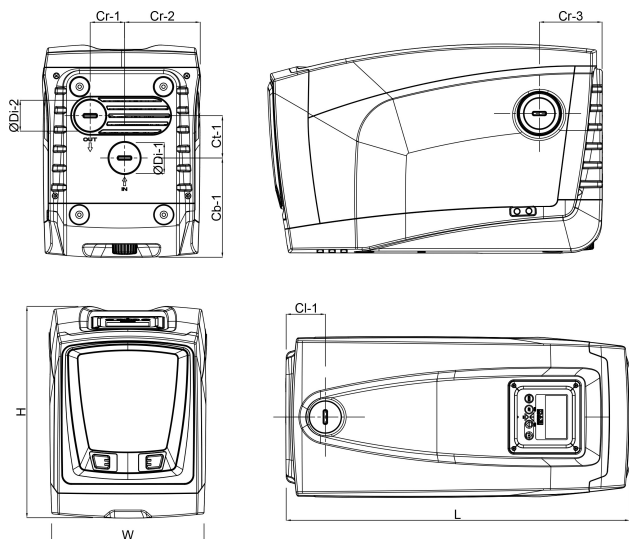

PRODUCT INFORMATION

Includes a self-priming, multi-stage pump with electronic inverter management, pressure and flow sensors, adjustable, high resolution LCD display and an integrated 2 litre expansion tank. Suitable for use with potable water, in domestic systems and gardening applications.

Noise: 43dB under normal use.

Pressure Set Point adjustable from 1 up to 6 bar

Max. Suction Depth: 8 metres

Installation: Horizontal or vertical fixed position

Last modified date: 27/05/2026

Bosta UK Ltd.
Reflection House
Olding Road
Bury St. Edmunds
Suffolk
IP33 3TA
T +44 (0) 1284 716580
E enquiries@bosta.co.uk
<http://www.bosta.com>