

**3-way ball valve L-bore PVC-U
20 mm glue socket 10bar DN15
grey type L-bore side
connection (0111641)**



TECHNICAL SPECIFICATIONS

Colour grey

Type L-bore

Material PVC-U

Operation lever

Colour lever red

Handle material PVC-U

Material housing PVC-U

Material seal PTFE/EPDM

Ball bore L-bore

Connection type side connection

Connection glue socket

Temperature range 0°C - 60°C

Pressure 10 bar

Size 20 mm

DN 15

DIMENSIONS

Ct-1 56 mm

Lb 112 mm

R 85 mm

\varnothing Df 15 mm

\varnothing Di-1 20 mm

\varnothing Di-2 20 mm

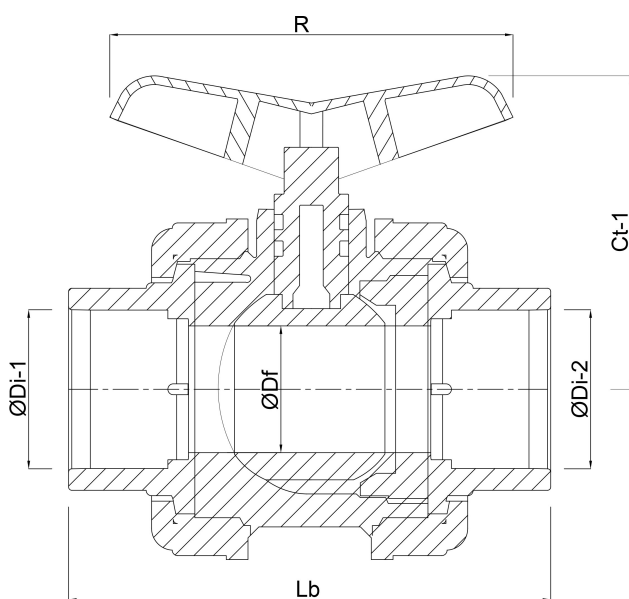

Last modified date: 23/05/2026

Bosta UK Ltd.
Reflection House
Olding Road
Bury St. Edmunds
Suffolk
IP33 3TA
T +44 (0) 1284 716580
E enquiries@bosta.co.uk
<http://www.bosta.com>