

VDL Ball valve PVC-U 40 mm glue socket 16bar grey type DIL viton (7018380)



VDL Van de Lande

TECHNICAL SPECIFICATIONS

Colour grey

Type DIL viton

Material PVC-U

Operation lever

Colour lever green

Handle material PVC-U

Housing construction 3-part

Material seal viton

Connection glue socket

Temperature range 0°C - 60°C

Size 40 mm

Pressure 16 bar

DIMENSIONS

Ct-1 75 mm

Lb 122 mm

R 106 mm

ØDf 32 mm

ØDi-1 40 mm

ØDi-2 40 mm

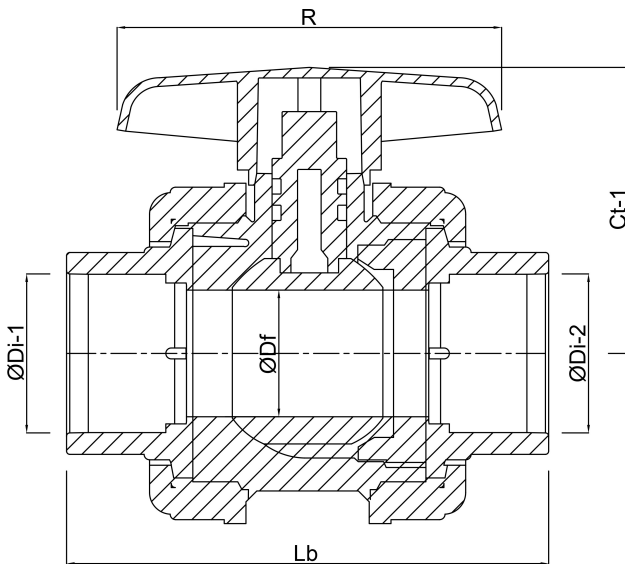

Last modified date: 25/05/2026

Bosta UK Ltd.
Reflection House
Olding Road
Bury St. Edmunds
Suffolk
IP33 3TA
T +44 (0) 1284 716580
E enquiries@bosta.co.uk
<http://www.bosta.com>