

Profec Flange flat steel DN65 x 76,1 mm DIN flange x butt welding 10bar PN10 (1180236)



TECHNICAL SPECIFICATIONS

Material	steel
Connection	DIN flange x butt welding
DIN Standard	DIN 2576
Flange	PN10
Pressure	10 bar
Size	DN65 x 76,1 mm
Inner ø	77,1 mm
Outer ø	185 mm
Weight	2.99 kg
Thickness	18 mm
PCD	145 mm
Bolt hole	18 mm
Holes	4

DIMENSIONS

O	18 mm
PCD	145 mm

ØDi-1

77.1 mm

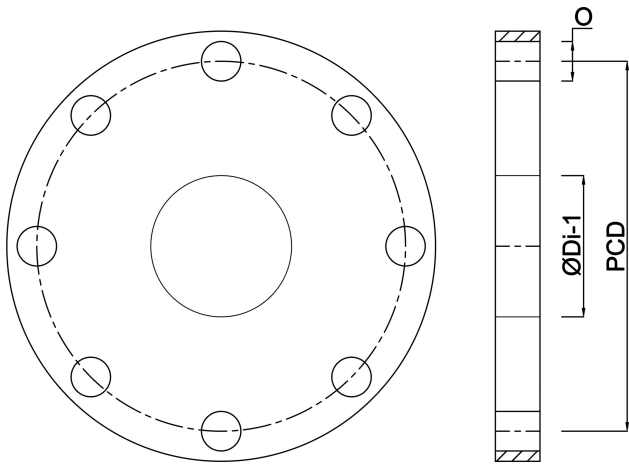

Last modified date: 24/05/2026

Bosta UK Ltd.
Reflection House
Olding Road
Bury St. Edmunds
Suffolk
IP33 3TA
T +44 (0) 1284 716580
E enquiries@bosta.co.uk
<http://www.bosta.com>