

Profec Ball valve PVC-U 20 mm glue socket 16bar DN20 grey type Safe 600 (0112101)



TECHNICAL SPECIFICATIONS

Colour grey

Type Safe 600

Material PVC-U

Operation lever

Colour lever red

Handle material PVC-U

Housing construction 3-part

Material housing PVC-U

Material seal hytrel/EPDM

Connection glue socket

Max. temperature 60 °C

Minimum medium temperature 0 °C
(continuous)

Pressure 16 bar

Size 20 mm

DN 20

DIMENSIONS

Ct-1 46 mm

Lb 84 mm

R 35 mm

ØDf 15 mm

ØDi-1 20 mm

ØDi-2 20 mm

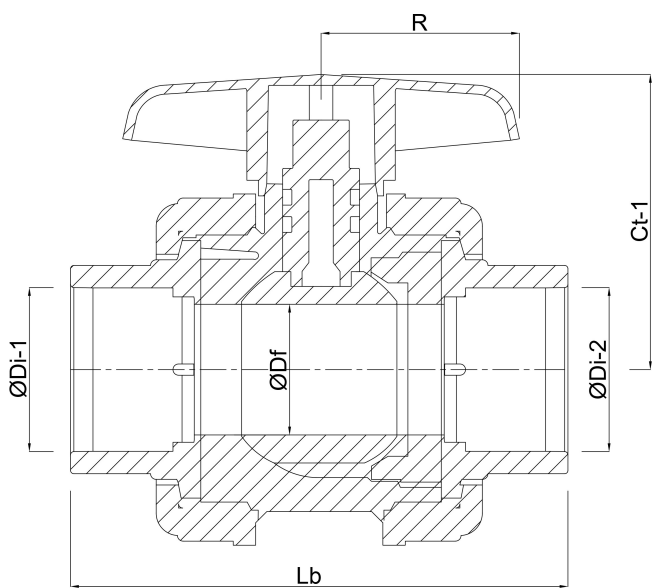

PRODUCT INFORMATION

With secure ball.

Last modified date: 07/03/2026

Bosta UK Ltd.
Reflection House
Olding Road
Bury St. Edmunds
Suffolk
IP33 3TA
T +44 (0) 1284 716580
E enquiries@bosta.co.uk
<http://www.bosta.com>