

Ball valve PVC-U 40 mm glue socket 16bar DN32 grey type AK (0161503)



TECHNICAL SPECIFICATIONS

Colour grey

Type AK

Material PVC-U

Operation lever

Colour lever red

Handle material PVC-U

Housing construction 3-part

Material housing PVC-U

Material seal PE/EPDM

Connection glue socket

Max. temperature 60 °C

Minimum medium temperature 0 °C
(continuous)

Size 40 mm

DN 32

Pressure 16 bar

DIMENSIONS

Ct-1 93 mm

Lb 148 mm

R 54 mm

ØDf 32 mm

ØDi-1 40 mm

ØDi-2 40 mm

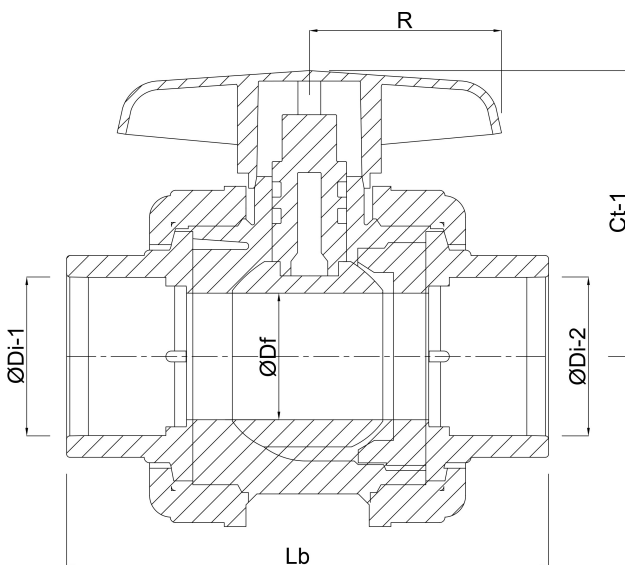

Last modified date: 23/05/2026

Bosta UK Ltd.
Reflection House
Olding Road
Bury St. Edmunds
Suffolk

IP33 3TA
T +44 (0) 1284 716580
E enquiries@bosta.co.uk
<http://www.bosta.com>