

**Profec Flange threaded steel
DN80 x 3" DIN flange x female
thread 16bar black PN10/16
(1180217)**



TECHNICAL SPECIFICATIONS

Colour	black
Material	steel
Connection	DIN flange x female thread
DIN Standard	DIN 2566
Flange	PN10/16
Pressure	16 bar
Size	DN80 x 3"
Diameter	88,9 mm
Outer ø	200 mm
Weight	3.95 kg
Height	34 mm
Thickness	20 mm
PCD	160 mm
Bolt hole	18 mm
Holes	4

DIMENSIONS

O 18 mm

PCD 160 mm

ØDi-1 3 "

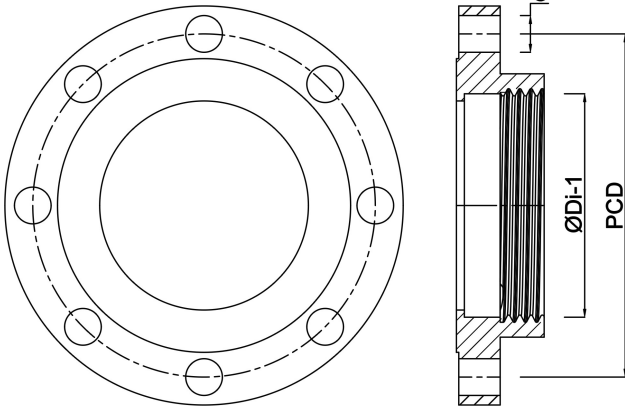

Last modified date: 24/05/2026

Bosta UK Ltd.
Reflection House
Olding Road
Bury St. Edmunds
Suffolk
IP33 3TA
T +44 (0) 1284 716580
E enquiries@bosta.co.uk
<http://www.bosta.com>