

Profec Ball valve brass nickel plated 1" female thread x male thread 25bar type 104 (0403019)



TECHNICAL SPECIFICATIONS

Type	104
Material	brass
Surface treatment	nickel plated
Operation	lever
Colour lever	red
Handle material	steel
Ball material	hard chrome plated brass
Material housing	brass
Material seal	PTFE
Connection	female thread x male thread
Temperature range	-20°C - 120°C
Pressure	25 bar
Size	1"

DIMENSIONS

Ct-1	56.9 mm
F-1	14 mm

F-2 14 mm

Lb 70,8 mm

R 126.3 mm

ØDf 24 mm

ØDi-2 1 "

ØDo-1 1 "

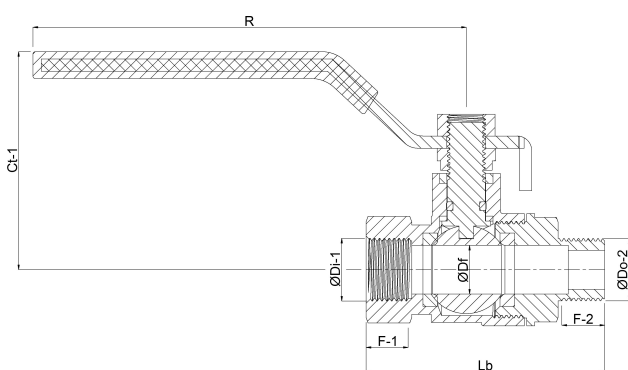

Last modified date: 23/05/2026

Bosta UK Ltd.
Reflection House
Olding Road
Bury St. Edmunds
Suffolk
IP33 3TA
T +44 (0) 1284 716580
E enquiries@bosta.co.uk
<http://www.bosta.com>