

Hydro-S Butterfly valve PVC-U
125/140 mm flange 10bar
DN140 grey PN10 type 7500
(7014382)



hydro-s

TECHNICAL SPECIFICATIONS

Colour grey

Type 7500

Material PVC-U

Operation lever

Colour lever blue

Material valve PVC-U

Material spindle steel

Material housing PP GF

Material seal EPDM

Connection flange

Flange PN10

Temperature range 0°C - 40°C

Size 125/140 mm

DN 140

Width 63 mm

Pressure 10 bar

Bolt hole 23 mm

DIMENSIONS

Ct-1 222 mm

PCD 210 mm

R 258 mm

W-1 63 mm

W-2 115 mm

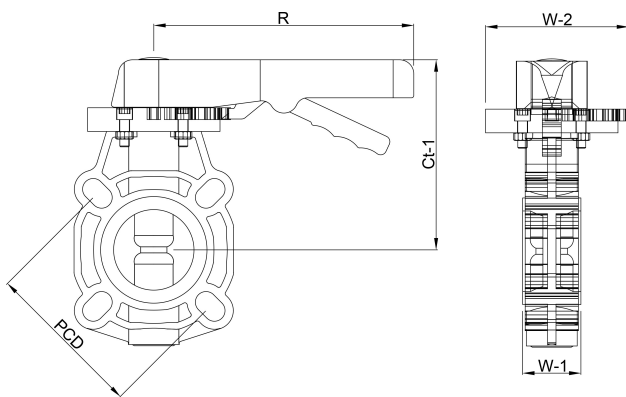

Last modified date: 25/05/2026

Bosta UK Ltd.
Reflection House
Olding Road
Bury St. Edmunds
Suffolk
IP33 3TA
T +44 (0) 1284 716580
E enquiries@bosta.co.uk
<http://www.bosta.com>