

**Profec Flange threaded steel
zinc plated DN80 x 3" DIN
flange x female thread DN80
PN10/16 (1080217)**



TECHNICAL SPECIFICATIONS

Material	steel
Surface treatment	zinc plated
Connection	DIN flange x female thread
DIN Standard	DIN 2566
Flange	PN10/16
Size	DN80 x 3"
Bolt	M16
DN	80
Diameter	88,9 mm
Outer ø	200 mm
Weight	4.12 kg
Thickness	20 mm
Bolt hole	18 mm
Holes	8

DIMENSIONS

O	18 mm
---	-------

PCD

160 mm

ØDi-1

3 "

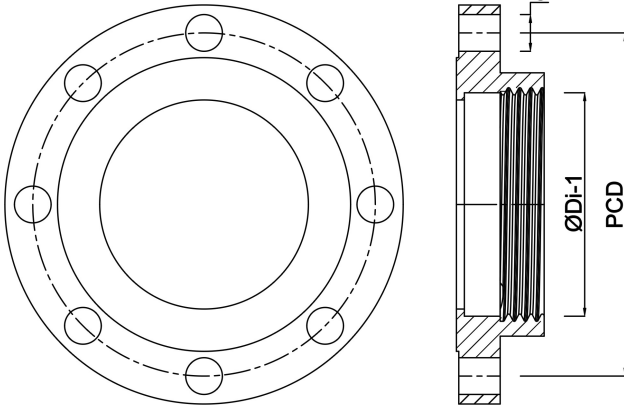

Last modified date: 24/05/2026

Bosta UK Ltd.
Reflection House
Olding Road
Bury St. Edmunds
Suffolk
IP33 3TA
T +44 (0) 1284 716580
E enquiries@bosta.co.uk
<http://www.bosta.com>