

**Foras Centrifugal pump cast  
iron 1 1/4" x 1" female thread  
8bar 10,3A 230VAC blue type  
KM 214 M (0920258)**



# TECHNICAL SPECIFICATIONS

Colour blue

Material cast iron

Material impeller 1 brass

Connection female thread

Seal type B

Max. temperature 90 °C

Minimum medium temperature 0 °C  
(continuous)

Press 1 "

Maximum ambient temperature 40 °C

Suction 1 1/4 "

Minimum ambient temperature 0 °C

Type KM 214 M

Output Power 2,2 HP

Max. head 45,1 m

Size 1 1/4" x 1"

Length 348 mm

Voltage 230VAC

Width 225 mm

Weight 24 kg

Power 1.65 kW

Height 285 mm

Max flow rate 7.2 m<sup>3</sup>/h

BEP Capacity 7.2

BEP Head 33

Efficiency 40 %

Packaging dimensions L/W/H 370 x 240 x 315 mm

## DIMENSIONS

Cb-1 115 mm

Cl-1 46.5 mm

G-1 180 mm

H 285 mm

H 285 mm

L 348 mm

Lb 117 mm

W-1 220 mm

W-2 225 mm

ØDi-1 1 1/4 "

ØDi-2 1 "

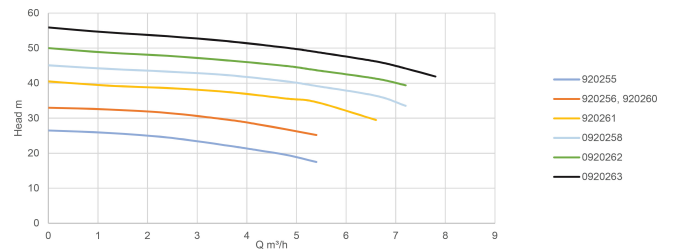
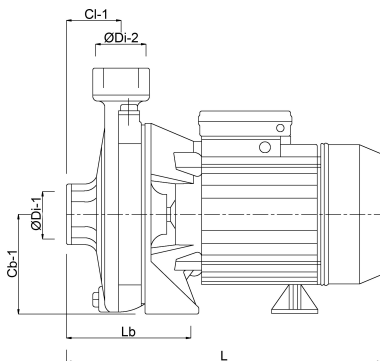

## PRODUCT INFORMATION

Mechanical seal.

Oversized self-lubricating bearings.

Sealed motor with external cooling.

Electrical winding Class F Condenser - thermo - amperometric safety (only in mono).

The maximum water temperature is 90°C.

Supplied without cable.

**Last modified date: 08/05/2026**

Bosta UK Ltd.  
Reflection House  
Olding Road  
Bury St. Edmunds  
Suffolk  
IP33 3TA  
T +44 (0) 1284 716580

[E enquiries@bosta.co.uk](mailto:enquiries@bosta.co.uk)

<http://www.bosta.com>