

**Ball valve PVC-U 1" female
thread 10bar DN25 grey type
AK (0161512)**



TECHNICAL SPECIFICATIONS

Colour grey

Type AK

Material PVC-U

Operation lever

Colour lever red

Handle material PVC-U

Housing construction 3-part

Material housing PVC-U

Material seal PE/EPDM

Connection female thread

Max. temperature 60 °C

Minimum medium temperature 0 °C
(continuous)

Pressure 10 bar

Size 1"

DN 25

DIMENSIONS

Ct-1 65 mm

Lb 111 mm

R 45 mm

ØDf 25 mm

ØDi-1 1 "

ØDi-2 1 "

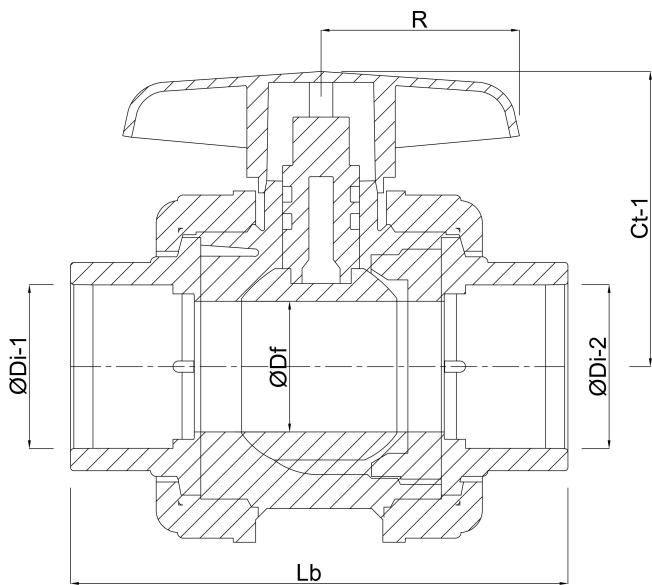

Last modified date: 07/03/2026

Bosta UK Ltd.
Reflection House
Olding Road
Bury St. Edmunds

Suffolk
IP33 3TA
T +44 (0) 1284 716580
E enquiries@bosta.co.uk
<http://www.bosta.com>