

Counter current pump 75 mm glue socket 400VAC type STP- 2200SS (7025322)



TECHNICAL SPECIFICATIONS

Connection glue socket

Type STP-2200SS

Output Power 3 HP

Size 75 mm

Voltage 400VAC

Power 2.2 kW

Max flow rate 55 m³/h

IP value IP55

DIMENSIONS

A 370 mm

B 156 mm

C 440 mm

D 75 mm

E 357 mm

F 77 mm

G 1110 mm

H

340 mm

h1

635 mm

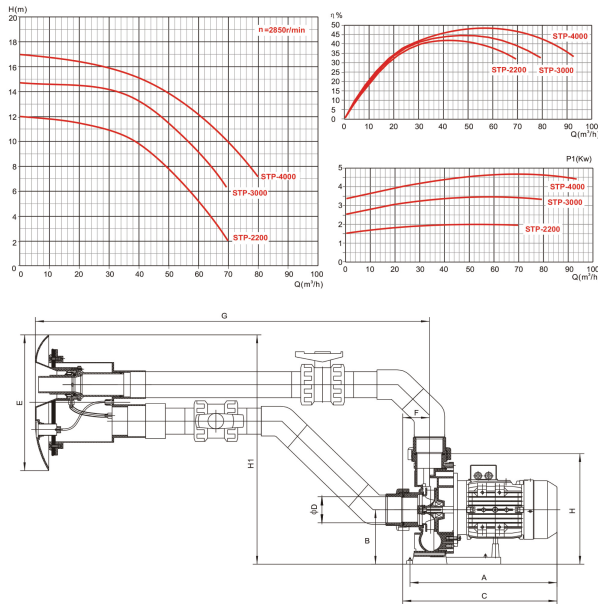

PRODUCT INFORMATION

Adjustable counterflow for swimming training. This jet stream is ready for easy installation. It is possible to regulate the jet strength and air suction on the nozzle which is 40 mm in diameter. The direction of the nozzle is adjustable. The nozzle, suction and pneumatic switch are positioned in the front cover panel of the equipment.

Features:

- Suitable for all type of pools
- Counterflow nozzle 40 mm (regulation water-air)
- Front cover panel with attractive design Electropneumatic switch with safety element
- IP 55 protection
- Insulation: Class F
- Motor shaft in stainless steel AISI-304

- Motor housing in aluminium L-2521
- Including 2 x 75mm ball vales

Last modified date: 09/03/2026

Bosta UK Ltd.
Reflection House
Olding Road
Bury St. Edmunds
Suffolk
IP33 3TA
T +44 (0) 1284 716580
E enquiries@bosta.co.uk
<http://www.bosta.com>