

**Ball valve brass nickel plated
3/8" female thread 210bar type
Hipress 2321 (0401275)**



TECHNICAL SPECIFICATIONS

Type	Hipress 2321
Material	brass
Surface treatment	nickel plated
Operation	lever
Colour lever	black
Handle material	aluminium
Housing construction	2-part
Material housing	brass
Material seal	PTFE
Connection	female thread
Temperature range	-10°C - 80°C
Pressure	210 bar
Size	3/8"
Norm	UNI/ISO 7/1

DIMENSIONS

Ct-1	54 mm
------	-------

F-1 12 mm

F-2 12 mm

Lb 75 mm

R 73 mm

ØDf 8 mm

ØDi-1 3/8 "

ØDi-2 3/8 "

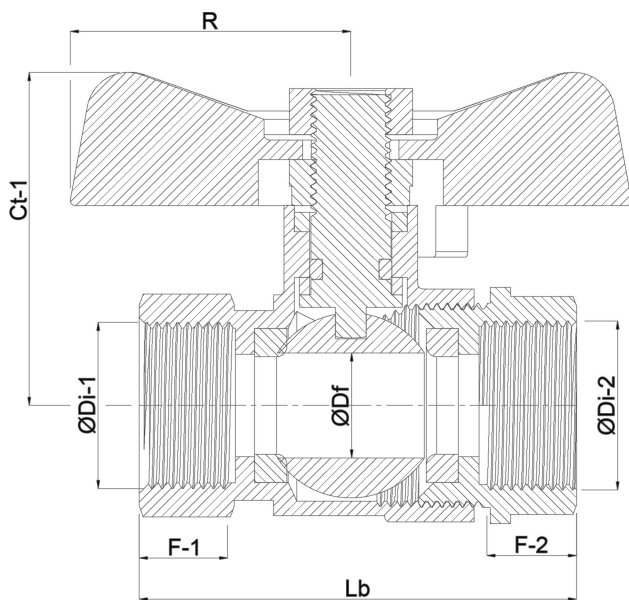

Last modified date: 23/05/2026

Bosta UK Ltd.
Reflection House
Olding Road
Bury St. Edmunds
Suffolk
IP33 3TA

T +44 (0) 1284 716580
E enquiries@bosta.co.uk
<http://www.bosta.com>