

**Profec Blind flange PVC-U
DN40 x 50 mm DIN flange
16bar DN40 grey PN10/16
(0111023)**



TECHNICAL SPECIFICATIONS

Colour	grey
Material	PVC-U
Connection	DIN flange
Size	DN40 x 50 mm
Bolt	M16
Packaging	70 pcs
DN	40
Flange	PN10/16
Outer ø	150 mm
Weight	0.327 kg
Length bolt	75 mm
Thickness	16 mm
Pressure	16 bar
Bolt hole	18 mm
Holes	4

DIMENSIONS

O 18 mm

PCD 111 mm

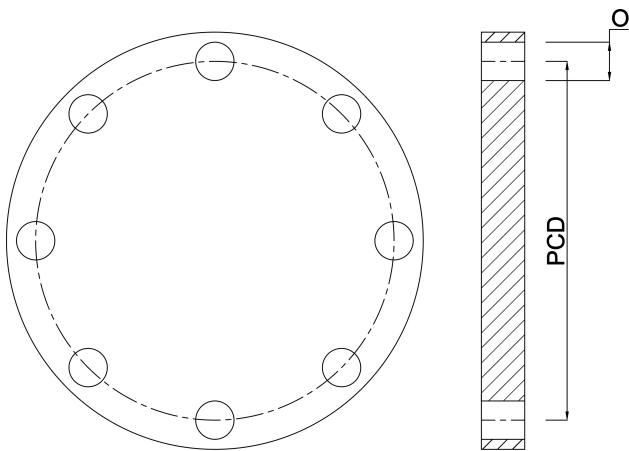

PRODUCT INFORMATION

For PCD, bolt hole size and number see Technical specifications "How to identify a flange" at the back of the catalogue (PCD equals K)

Last modified date: 23/05/2026

Bosta UK Ltd.
Reflection House
Olding Road
Bury St. Edmunds
Suffolk
IP33 3TA
T +44 (0) 1284 716580
E enquiries@bosta.co.uk
<http://www.bosta.com>