

**Drainage repair socket rubber
reinforced with nylon 50 mm x
1 - 1 1/4" spigot x siphon seal
black (0300262)**



TECHNICAL SPECIFICATIONS

Colour	black
Material	rubber reinforced with nylon
Connection	spigot x siphon seal
Size	50 mm x 1 - 1 1/4"

DIMENSIONS

L 22 mm

ØDi-2 50 mm

ØDo-1 1 1/4 "

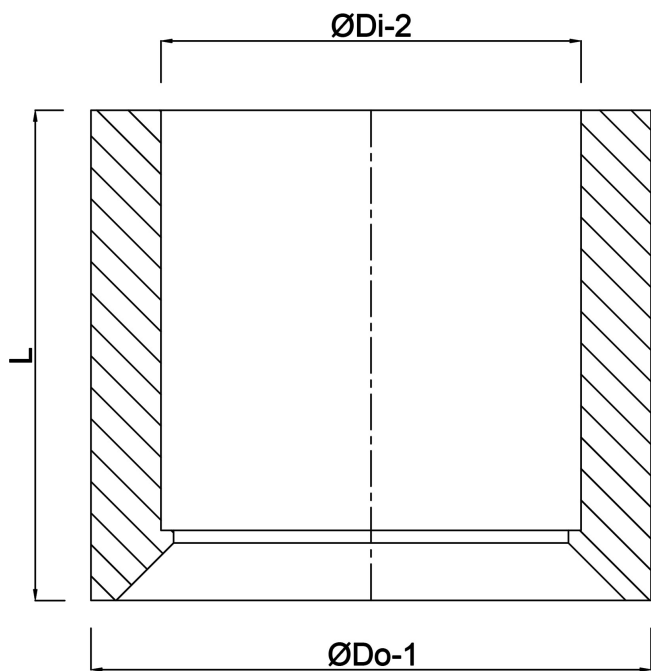

Last modified date: 13/03/2026

Bosta UK Ltd.
Reflection House
Olding Road
Bury St. Edmunds
Suffolk
IP33 3TA
T +44 (0) 1284 716580
E enquiries@bosta.co.uk
<http://www.bosta.com>