

**VIR Ball valve brass chrome
plated 2" male thread 40bar
WRAS/VA type K348 (0401271)**



TECHNICAL SPECIFICATIONS

Type	K348
Material	brass
Surface treatment	chrome plated
Approval	WRAS/VA
Operation	lever
Colour lever	red
Handle material	dacromet steel
Housing construction	2-part
Ball material	hard chrome plated brass
Material housing	brass
Material seal	PTFE
Connection	male thread
Flow	full
Temperature range	0°C - 150°C
Pressure	40 bar
Size	2"

DIMENSIONS

Ct-1 87 mm

F-1 21 mm

F-2 21 mm

Handle height 87

Lb 134 mm

R 141.5 mm

ØDf 50 mm

ØDo-1 2 "

ØDo-2 2 "

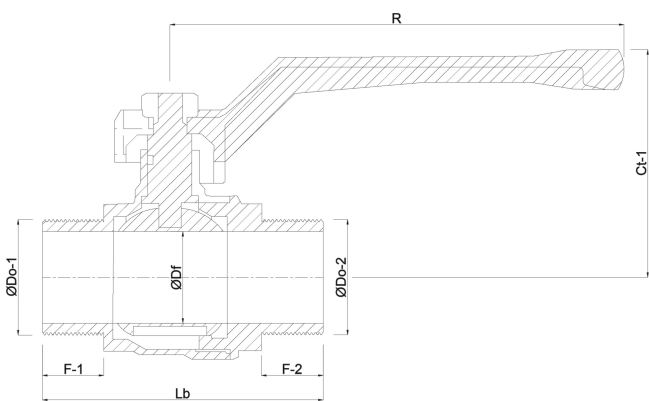

Last modified date: 07/03/2026

Bosta UK Ltd.
Reflection House

Olding Road
Bury St. Edmunds
Suffolk
IP33 3TA
T +44 (0) 1284 716580
E enquiries@bosta.co.uk
<http://www.bosta.com>