

**Backing ring PP/steel PP 50  
mm SDR11 16bar DN40 black  
PN10/16 (7031731)**



# TECHNICAL SPECIFICATIONS

Colour black

Material PP/steel

Surface treatment PP

Class SDR11

Pressure 16 bar

Size 50 mm

DN 40

Flange PN10/16

Outer ø 150 mm

Weight 0.676 kg

Thickness 18 mm

Bolt hole 18 mm

Holes 4

## DIMENSIONS

O 18 mm

PCD 110 mm

ØDi-1

62 mm

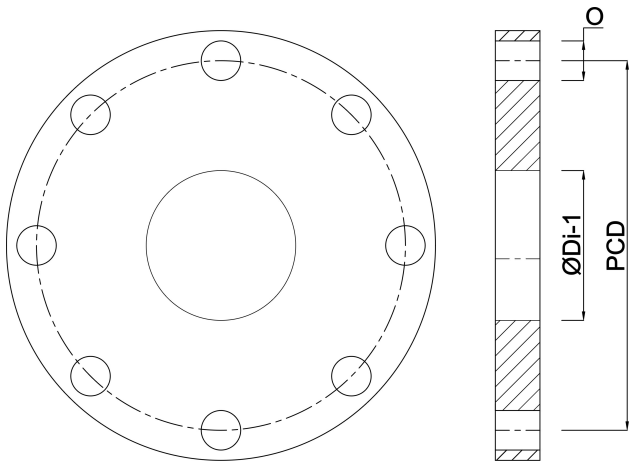

**Last modified date: 22/05/2026**

Bosta UK Ltd.  
Reflection House  
Olding Road  
Bury St. Edmunds  
Suffolk  
IP33 3TA  
T +44 (0) 1284 716580  
E [enquiries@bosta.co.uk](mailto:enquiries@bosta.co.uk)  
<http://www.bosta.com>